



boxercraft[®]

America's #1 Spiritwear Source[®]

Style Embellishment Guide

2019

Live Copy Update: July 2019

Last Hard Copy Distribution: July 2019

Con•dential File ©2019 Boxercraft

DEFINITIONS

* HPS = High Point Shoulder: the measurement from the top of the highest point of the shoulder of a garment to the top of the logo on the left chest.

FORMAT

*Book is color coded by

BLUE = TOPS

YELLOW = TANKS & DRESSES

ORANGE = PANTS

PURPLE = SHORTS

GREEN = OUTERWEAR

PINK = SPECIAL

INDIGO = INFANT

*Book is in numerical and alphabetical order by style and category

LOGOS

* Measurements shown are on left side of garment. Printing can be done on right side and other locations upon request.

* All logo sizing is "Boxercraft suggested" maximum sizing that we believe will look best.

* Customer may ask for special sizing but note smaller logos requested will be at customers own risk for print results based on complexity of logo.

* Anything requested larger than recommended sizing can be done once consulted with production staff and approved by customer.

* When customers request placement or sizing that is out of standard, production artist must note this on proof under special instructions.

* Print placements reflected in the style guide are "BOXERCRAFT" suggested placements to achieve optimum look and quality. Customers can request other placements on a garment. The only EXCEPTION is if in the "SPECIAL INSTRUCTIONS" section on the garment page points out a placement that is not capable of being done, then we need to relay that back to the customer.

* When making special requests for lettering please note lettering is created as one piece of art work, if a customer wants letters to be a uniform size/ individual letters (i.e. ALL LETTERS 4") same size that has to be noted to the art team to create all individual letters per customer.

* A note saying customer wants (i.e. 4" on top line lettering and 2" on bottom line lettering will be helpful)

* Proof art pictures given to customers are not actual size please refer to written measurements of artwork when approving.

* Prints on stretch fabrics will appear smaller on hanger but are actual size when worn.

* Printing is NOT AVAILABLE across zippers or seams.

CUSTOMER SERVICE

• Please note that on all lettering created for pants and sleeves lettering can be horizontal or stacked.

GREY UNDERLAY

*Art could require a grey underlay dependent upon the garment, garment/color, or art.

TOPS

D02/YD02	Rally Corduroy Crew
F50/PF50	Ladies Essential Flannel Buttondown
F51/YF51	Men's Essential Flannel Buttondown
FZ03/YFZ03	Fuzzy Fleece Crew
L01/YL01	Cozy Crew
L04	Cozy Contrast Pullover
L06/YL06	Cuddle Boxy Crew
L07/PL07	Cuddle V-Neck Hoodie
L08	Cuddle Cardigan
L12	Cuddle Cowl Pullover
R42	Stadium Cropped Hoodie
T05/YT05	Just For You Crew
T07/YT07	Vintage Tee
T09/YT09	Long Sleeve Vintage Tee
T14/YT14	Pom Pom Jersey
T17/YT17	V-Slub Pom Pom
T18/YT18	Hooded Pom Pom
T19	Vintage Jersey
T23/YT23	Relaxed V-Tee
T24/YT24	Flirty Crew
T27/PT27/YT27	Caged Front Tee
T29	Essential Long Sleeve Tee
T31/PT31	Long Sleeve Cold Shoulder Tee
T32/PT32/YT32	Cold Shoulder Tee
T33	Long Sleeve Snow Heather V-Tee
T34/YT34	Snow Heather V-Tee
T36/YT36	Glory Days Tee
T47/YT47	Ladies Ringer Tee
T49/YT49	Men's Ringer Tee
T52/YT52	Twisted Tee
T53	Moxie Tee
T54/YT54	Arena Tee
T57/YT57	Vintage Cuff Tee
T61	Flowy Scoop Neck Tee
T62/PT62/YT62	Sporty Slub Tee
T65/YT65	Powder Puff Tee
T66/PT66/YT66	Preppy Patch Tee
V03	Rally Lace-up Pullover
V04/YV04	Rally Crew Pullover

TANKS & DRESSES

S101 /YS101	Support Your Team Bra
T48/YT48	Ringer Tank
T51/YT51	Ringer Dress
T56/YT56	Vintage Charm Tank
T59	All-Star Dress
T81/YT81	Tiger Stripe Tank
T83	Sleepy Cover Up
T88/YT88	At Ease Tank
T89	Margo Tank

PANTS

C16	V.I.P. Cotton Pant
F20/YF20	Flannel Pant
F24	Men's Classic Flannel Pant
F60	Tailgate Jogger
J15/YJ15	Margo Pant
K21/YK21	Rally Jogger
K60/YK60	Men's Classic Jogger
L09	Cuddle Jogger
L10	Cuddle Wide Leg Pant
R43/YR43	Ladies Stadium Jogger
R44	Men's Stadium Jogger
S08/YS08	Love 'Em Longer Legging
S16/YS16	Practice Pant
S34/YS34	Practice Capri

SHORTS

C41	V.I.P. Cotton Short
F41/YF41	V.I.P. Short
F42	Ladies Essential Flannel Short
F48	Men's Classic Flannel Boxer
K11/YK11	Rally Short
L11	Cuddle Short
M68	Full Court Mesh Short
P60/YP60	Elite Short
P62/YP62	Velocity Short
R65/YR65	Relay Short
R70/YR70	Men's Stadium Short

OUTERWEAR

D03	Rally Corduroy Quarter Zip Pullover
D04	Rally Corduroy Hoodie
FZ01	Ladies Fuzzy Fleece Pullover
FZ02	Fuzzy Fleece Quarter Zip Pullover
P63	Ladies Stadium Anorak
Q10/YQ10	Sherpa Quarter Zip Pullover
Q11/YQ11	Sherpa Full Zip Vest
Q12/YQ12	Ladies Full Zip Sherpa Jacket
Q13	Men's Full Zip Sherpa Jacket
Q15/YQ15	Sherpa Pullover Hoodie
Q19/YQ19	Sherpa Line Fleece Full Zip Hoodie
Q20	Varsity Sherpa
S89/YS89	Practice Jacket
S95/PS95/YS95	Studio Jacket

INFANT

GRB01	Infant Short Sleeve Onesie
GRB02	Infant Long Sleeve Onesie
GRB03	Infant Bib

SPECIAL

FB250	Flannel Blanket
Q21	Sherpa Blanket
U01	Polar Fleece Union Suit

R

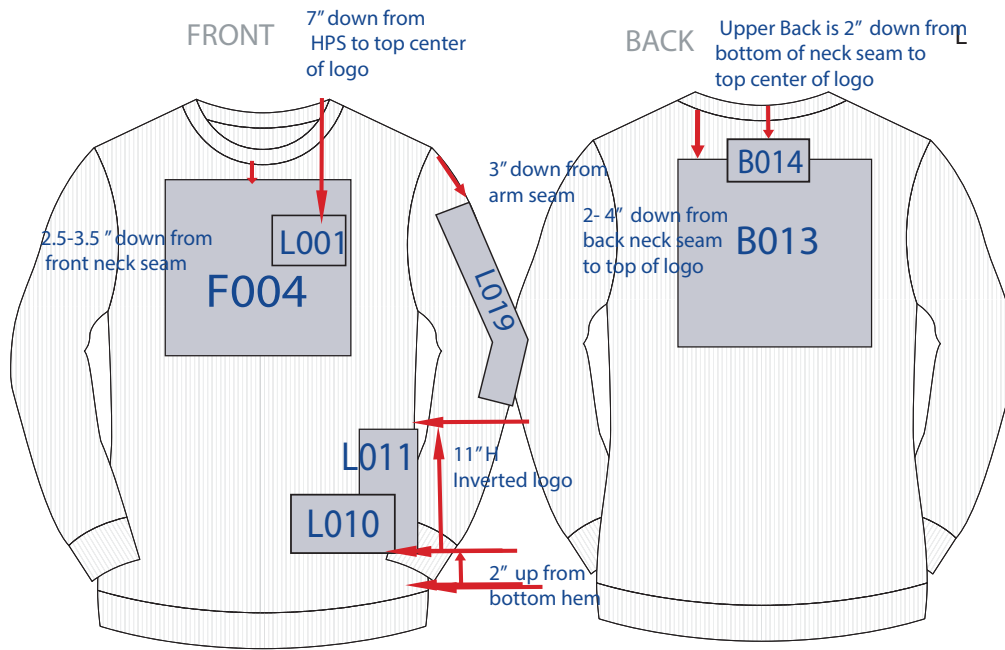

INFORMATION

*Available in:

Adult XS - 3X
Youth YS-YL

* 8.3 oz. 60/40 Cotton/ Polyester Enzyme & Stone washed Corduroy Knit (exclusive of decoration)
* Rib neckband/sleeve cuffs/ bottom band

SPECIAL INSTRUCTIONS

Screen print & embroidery
*NO SMALL DETAILS OR DISTRESSED ART on left chest

F004 FRONT CENTER

ADULT : 12W x 12H MAX
PLACEMENT : Centered 2.5" - 3.5" from neck seam to top of logo
YOUTH: 10W x 10H MAX
PLACEMENT : Centered 1.5" - 2.5" from neck seam to top of logo

L001 LEFT CHEST

ADULT : 3W x 3H MAX
PLACEMENT : 7" down from High Point Shoulder point
YOUTH: 2W x 2H MAX
PLACEMENT : 7" down from High Point Shoulder point

B013 BACK CENTER

ADULT : 14W x 12H MAX
PLACEMENT : 2"-4" down from neck seam to top of logo
YOUTH: 12W x 10H MAX
PLACEMENT : 2"-4" down from neck seam to top of logo

B014 UPPER BACK CENTER

ADULT : 3W x 3H MAX
PLACEMENT : 2"-4" down from neck seam to top of logo
YOUTH: 2W x 2H MAX
PLACEMENT : 2" down from bottom center neck seam centered on back neck

L019 FULL SLEEVE

ADULT: 3W x 12H MAX
PLACEMENT : 3.5" down from arm seam
YOUTH: 2W x 10H MAX
PLACEMENT : 2.5" down from arm seam

L011 INVERTED HEM

ADULT : 3W x 11H MAX
PLACEMENT : 2"-4" down from bottom hem to bottom of logo

YOUTH: 2W x 8H MAX

L010 SHIRT HEM

ADULT : 4W x 4H MAX
PLACEMENT : 2" up from bottom hem to bottom of logo

YOUTH: 3W x 3H MAX
PLACEMENT : 2" up from bottom hem to bottom of logo

AVAILABLE PROCESSES:



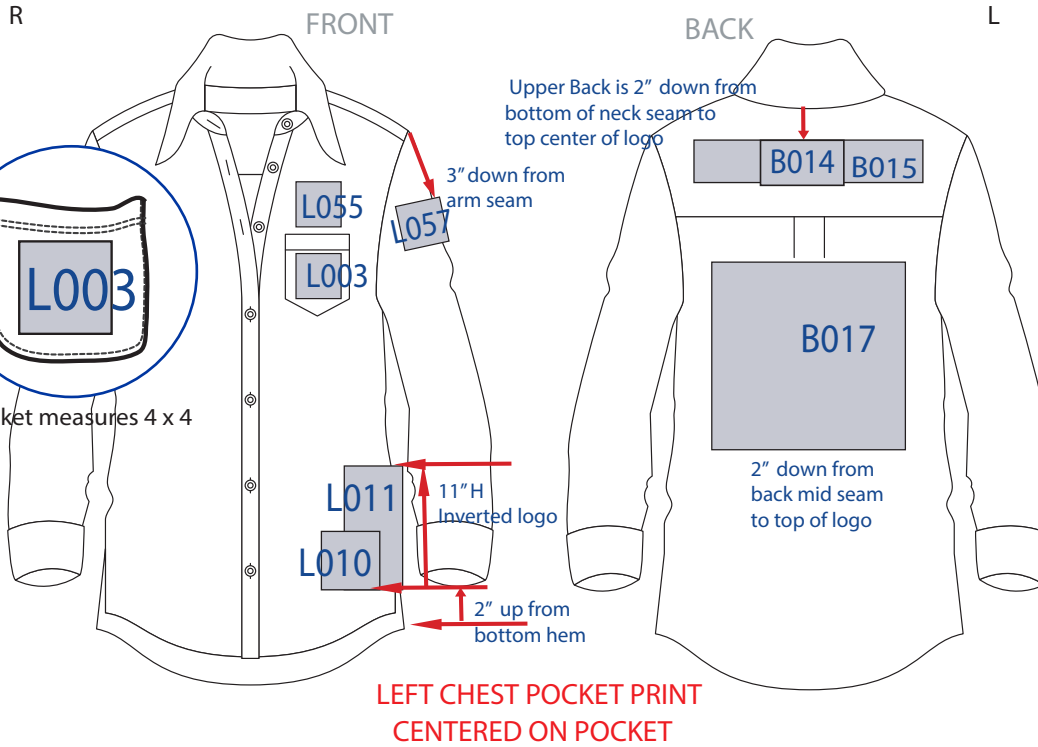

INFORMATION

- *Available in:
 - Adult XS - 3X
 - Plus 1XP - 4XP
- * 4.3 oz. 100% Double-Brushed Cotton Flannel (Exclusive of decoration)
- * Collar stand neck
- * Button placket w/brass buttons
- * Diagonal plaid on collar/front placket /pockets/cuffs/back yoke
- * Shirt tail high-low hem
- *available in youth as YF51

SPECIAL INSTRUCTIONS

Screen print & embroidery
 *no small details or distressed art for left chest or upper back center placements

L003 ON POCKET

ADULT : 3W x 3H MAX
 PLACEMENT: Centered inside pocket
 2" from top and bottom of pocket to place logo/
 Centered inside pocket
 Pocket measures 4 x 4

L055 ABOVE POCKET

ADULT : 3W x 3H MAX
 PLACEMENT : 1/2" up from pocket to bottom of logo

L010 SHIRT HEM

ADULT : 4W x 4H MAX
 PLACEMENT : 2" up from bottom hem to bottom of logo

L011 INVERTED HEM

ADULT : 3W x 11H MAX
 PLACEMENT : 2" up from bottom hem to edge of logo (Inverted Art)

B017 LOWER BACK

ADULT : 12W x 12H MAX
 PLACEMENT : 2"-4" down from upper back seam to top of logo

B014 UPPER BACK CENTER

ADULT : 3W x 3H MAX
 PLACEMENT : 2" down from bottom center neck seam centered on back neck

B015 UPPER BACK

ADULT : 12W x 3H MAX
 PLACEMENT : 2" down from bottom center neck seam centered on back neck

L057 SHOULDER SLEEVE

ADULT : 3W x 3H MAX
 PLACEMENT : 5" down from neck seam centered on sleeve

AVAILABLE PROCESSES:

S

S E

S

S

S

S E

S

S E

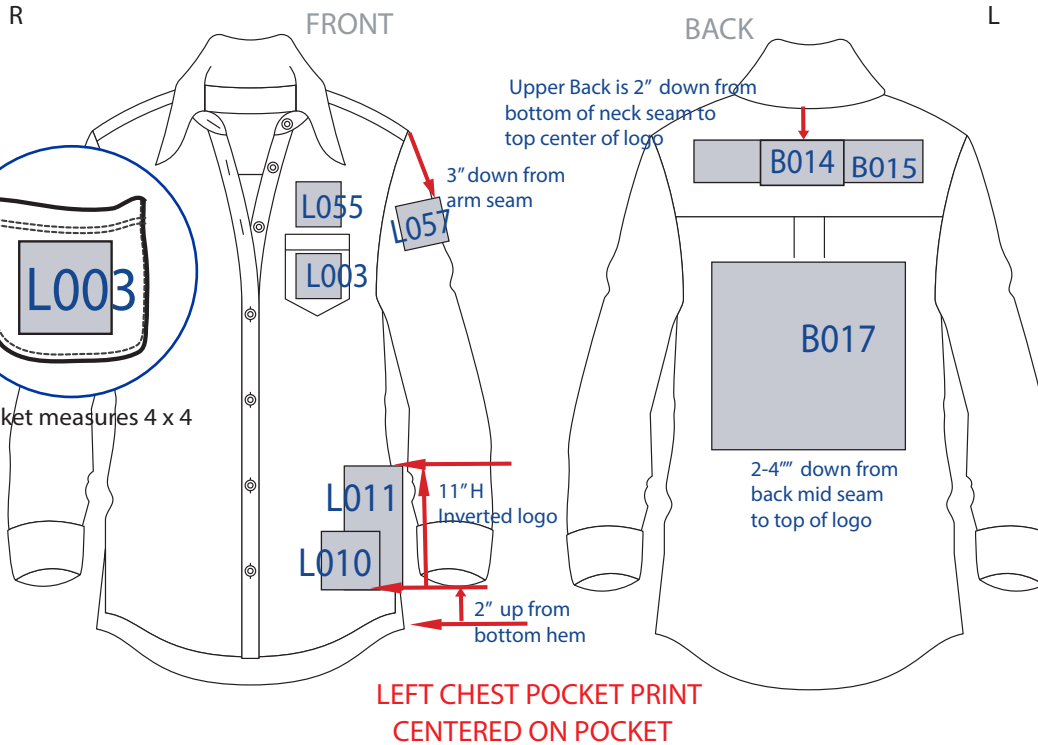

INFORMATION

- *Available in:
 - Adult XS - 3X
 - Youth YS - YL
- * 4.3 oz. 100% Double-Brushed Cotton Flannel (Exclusive of decoration)
- * Collar stand neck
- * Button placket w/brass buttons
- * Diagonal plaid on collar/front placket /pockets/cuffs/back yoke
- * Shirt tail high-low hem
- *available in youth as YF51

SPECIAL INSTRUCTIONS

Screen print & embroidery
 *no small details or distressed art for left chest or upper back center placements

L003 ON POCKET

ADULT : 3W x 3H MAX
PLACEMENT: Centered inside pocket
 2" from top and bottom of pocket to place logo/
YOUTH : 2W x 2H MAX
PLACEMENT: Centered inside pocket
 2" from top and bottom of pocket to place logo/

L055 ABOVE POCKET

ADULT : 3W x 3H MAX
PLACEMENT : 1/2" up from pocket to bottom of logo
YOUTH: 2W x 2H MAX
PLACEMENT: 1/2" up from pocket to bottom of logo

L010 SHIRT HEM

ADULT : 4W x 4H MAX
PLACEMENT : 2" up from bottom hem to bottom of logo
YOUTH : 3W x 3H MAX
PLACEMENT : 2" up from bottom hem to bottom of logo

L011 INVERTED HEM

ADULT : 3W x 11H MAX
PLACEMENT : 2" up from bottom hem to edge of logo (Inverted Art)
YOUTH : 2W x 8H MAX
PLACEMENT : 2" up from bottom hem to edge of logo (Inverted Art)

B017 LOWER BACK

ADULT : 12W x 12H MAX
PLACEMENT : 2"-4" down from upper back seam to top of logo
YOUTH: 10W x 10H MAX
PLACEMENT : 2"-4" down from upper back seam to top of logo

B014 UPPER BACK CENTER

ADULT : 3W x 3H MAX
PLACEMENT : 2" down from bottom center neck seam centered on back neck
YOUTH : 2W x 2H MAX
PLACEMENT : 2" down from bottom center neck seam centered on back neck

B015 UPPER BACK

ADULT : 12W x 3H MAX
PLACEMENT : 2" down from bottom center neck seam centered on back neck
YOUTH: 10W x 2H MAX
PLACEMENT : 2" down from bottom center neck seam centered on back neck

L057 SHOULDER SLEEVE

ADULT : 3W x 3H MAX
PLACEMENT : 2" down from neck seam centered on sleeve
YOUTH : 2W x 2H MAX
PLACEMENT : 2" down from neck seam centered on sleeve

AVAILABLE PROCESSES:

S

S E

S

S

S

S E

S

S E

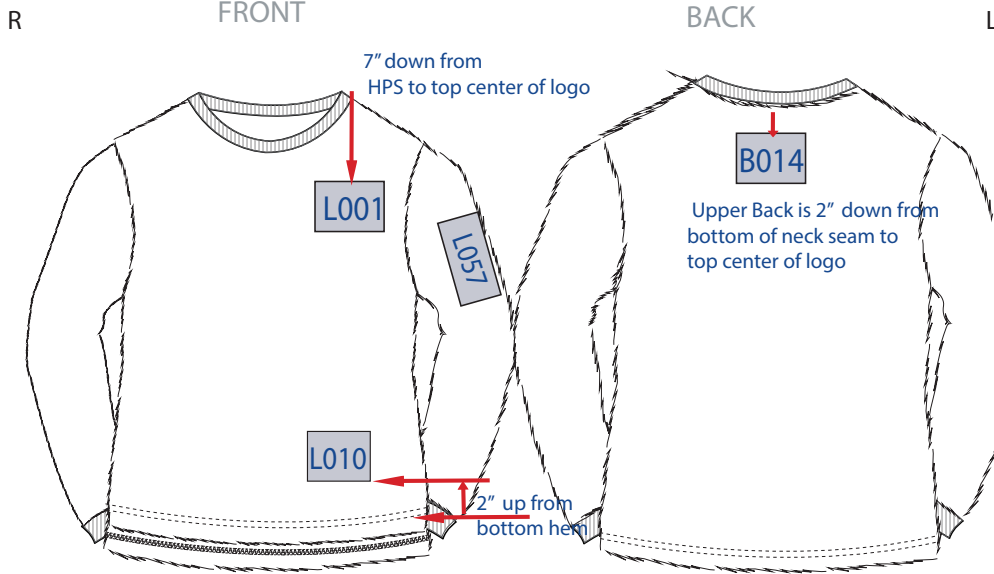

INFORMATION

- *Available in:
 - Adult XS - 3X
 - Youth YS - YL
- * 8.8 oz. 100% Polyester Fuzzy Fleece (Exclusive of decoration)
- * Rib neck band
- * Rib sleeve cuffs
- * Side vents

SPECIAL INSTRUCTIONS

- *Embroidery only
- * Tonal backing used

L001 LEFT CHEST

ADULT: 2.7W x 2.7H MAX
 PLACEMENT: 6.5" down from high point shoulder to top of logo
 YOUTH: 2.5W x 2.5H MAX
 PLACEMENT: 6" down from high point shoulder to top of logo

L010 SHIRT HEM

ADULT: 2.7W x 2.7H MAX
 PLACEMENT: 2" up from bottom hem to bottom of logo
 YOUTH: 2.5W x 2.5H MAX
 PLACEMENT: 2" up from bottom hem to bottom of logo

B014 UPPER BACK CENTER

ADULT: 2.7W x 2.7H MAX
 PLACEMENT: 2"-4" down from neck seam to top of logo
 YOUTH: 2.5W x 2.5H MAX
 PLACEMENT: 2" down from bottom center neck seam centered on back neck

L057 SHOULDER SLEEVE

ADULT: 2.7W x 2.7H MAX
 PLACEMENT: 2"-4" down from neck seam to top of logo
 YOUTH: 2.5W x 2.5H MAX
 PLACEMENT: 2" down from bottom arm hole seam centered on sleeve

AVAILABLE PROCESSES:

E

E

E

E

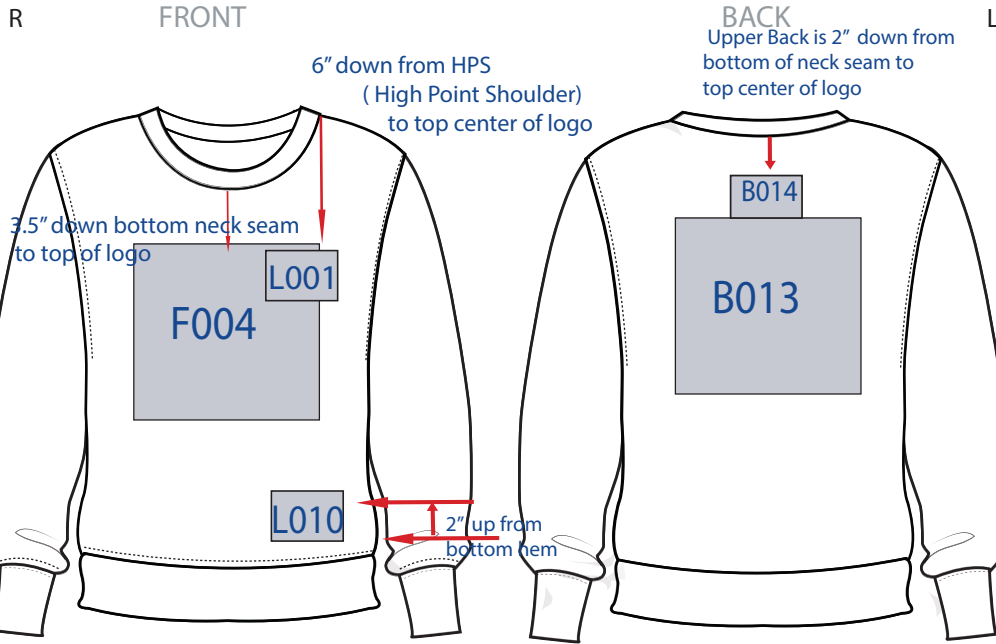

INFORMATION

- *Available in:
 - Adult XS- 2X
 - Youth YS - YL
- * Ladies
- * 50 / 50 Cotton / Poly
- * Self Fabric Cuffs

SPECIAL INSTRUCTIONS

- Screen print & Embroidery
- *NO SMALL DETAILS OR DISTRESSED ART
- *No Underlay

L001 LEFT CHEST

ADULT : 3W x 3H MAX
 PLACEMENT : 6" down from High Shoulder point
 2.5" over from center

YOUTH: 2 W x 2H MAX
 PLACEMENT : 6" down from High Shoulder point
 2.5" over from center

F004 FRONT CENTER

ADULT: 12W x 12H MAX
 PLACEMENT : 3.5" down under neck stitching

YOUTH: 10 W x 10H MAX
 PLACEMENT : 3.5" down under neck stitching

B014 UPPER BACK CENTER

ADULT: 3W x 3H MAX
 PLACEMENT : 1" down from the neck seam to top center of logo centered

YOUTH: 2W x 2H MAX
 PLACEMENT : 1" down from the neck seam to top center of logo centered

L010 SHIRT HEM

ADULT : 4W x 4H MAX
 PLACEMENT : 2" up from bottom hem to bottom of logo

YOUTH : 3W x 3H MAX
 PLACEMENT : 2" up from bottom hem to bottom of logo

B013 BACK CENTER

ADULT : 14W x 12H MAX
 PLACEMENT : 4" down from neck seam to top of logo centered

YOUTH : 12W x 10H MAX
 PLACEMENT : 4" down from neck seam to top of logo centered

AVAILABLE PROCESSES:



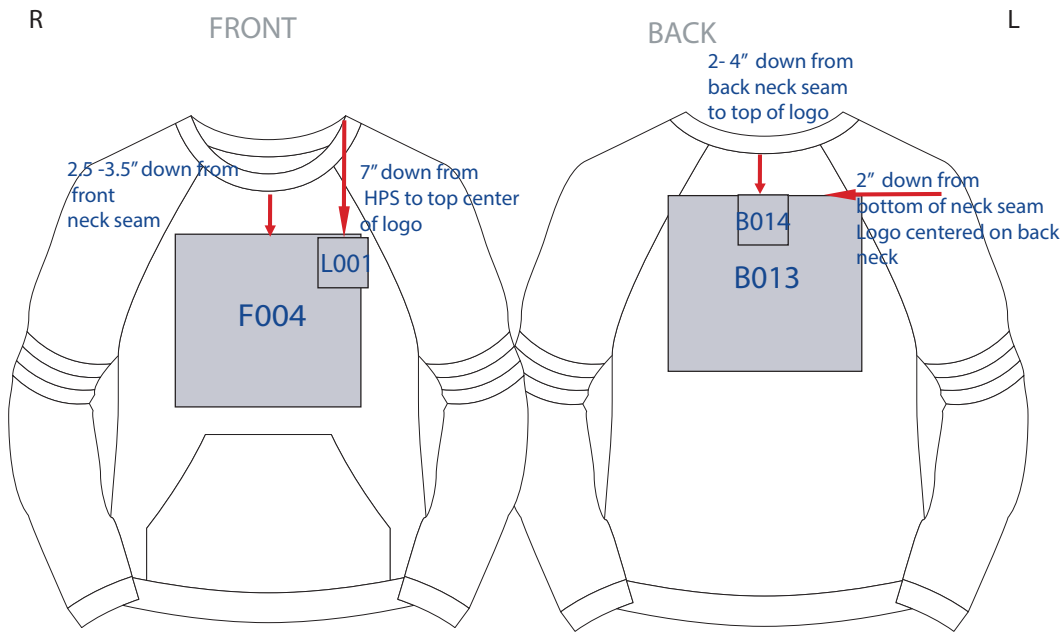

INFORMATION

*Available in:
Adult XS-3X

- * 5.9 oz. 80/17/3 Viscose/Polyester/Elastane Cuddle Knit (Exclusive of decoration)
- * Rib neck band and sleeve cuffs
- * High low hem
- * Side vent

SPECIAL INSTRUCTIONS

Screen print & Embroidery

F004 FRONT CENTER

ADULT : 10W x 8H MAX
PLACEMENT : Centered 2.5" - 3.5" from neck seam to top of logo

L001 LEFT CHEST

ADULT : 3W x 3H MAX
PLACEMENT : 7" down from High Point Shoulder point

B013 BACK CENTER

ADULT : 10W x 10H MAX
PLACEMENT : 2"-4" down from neck seam to top of logo

B014 UPPER BACK CENTER

ADULT : 3W x 3H MAX
PLACEMENT : 2" down from bottom neck seam & centered

AVAILABLE PROCESSES:



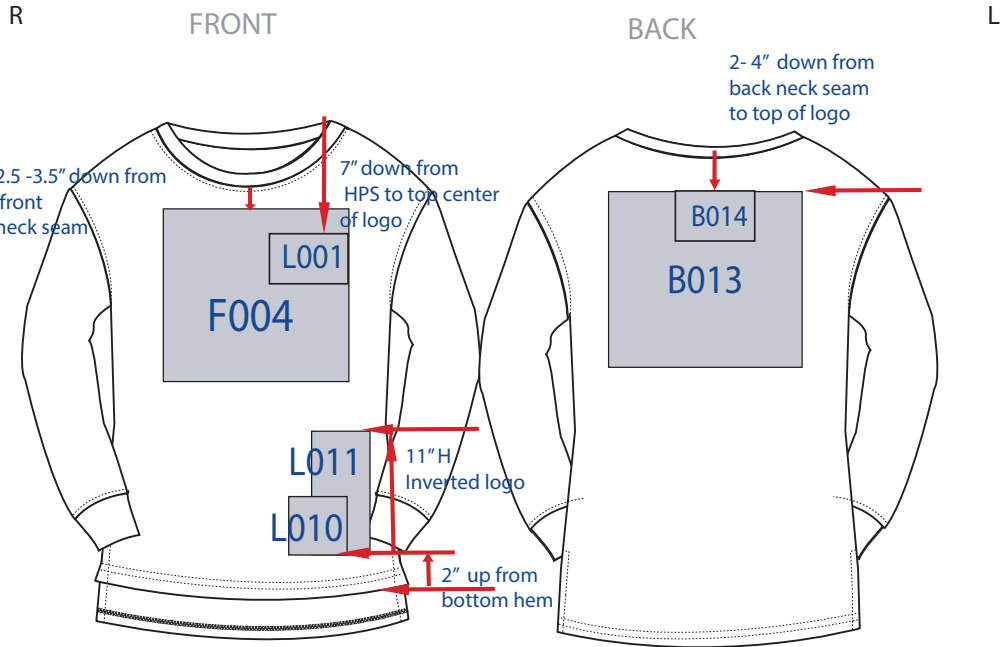

INFORMATION

*Available in:
 Adult XS-3X
 Youth YS-YL

* 5.9 oz. 80/17/3 Viscose/Polyester/
 Elastane Cuddle Knit (Exclusive of decoration)
 * Rib neck band and sleeve cuffs
 * High low hem
 * Side vent

SPECIAL INSTRUCTIONS

* Screen print & Embroidery
 * No small detail or distressed art on left chest

F004 FRONT CENTER

ADULT : 9W x 9H MAX
 PLACEMENT : Centered 2.5" - 3.5" from neck seam to top of logo

 YOUTH: 7W x 7H MAX
 PLACEMENT : Centered 1.5" - 2.5" from neck seam to top of logo

L001 LEFT CHEST

ADULT : 3W x 3H MAX
 PLACEMENT : 7" down from High Point Shoulder point

 YOUTH: 2W x 2H MAX
 PLACEMENT : 6" down from High Point Shoulder point

L010 SHIRT HEM

ADULT : 4W x 4H MAX
 PLACEMENT : 2" up from bottom hem to bottom of logo

 YOUTH: 3W x 3H MAX
 PLACEMENT : 2" up from bottom hem to bottom of logo

B013 BACK CENTER

ADULT : 10W x 10H MAX
 PLACEMENT : 2" - 4" down from neck seam to top of logo

 YOUTH: 8W x 8H MAX
 PLACEMENT : 2" - 4" down from neck seam to top of logo

L011 INVERTED HEM

ADULT : 3W x 11H MAX
 PLACEMENT : 2" - 4" down from bottom hem to bottom of logo

 YOUTH: 2W x 8H MAX
 PLACEMENT : 2" - 4" down from bottom hem to bottom of logo

B014 UPPER BACK CENTER

ADULT : 3W x 3H MAX
 PLACEMENT : 2" - 4" down from neck seam to top of logo

 YOUTH: 2W x 2H MAX
 PLACEMENT : 2" - 4" down from neck seam to top of logo

AVAILABLE PROCESSES:

- S
- S E
- S
- S
- S
- S

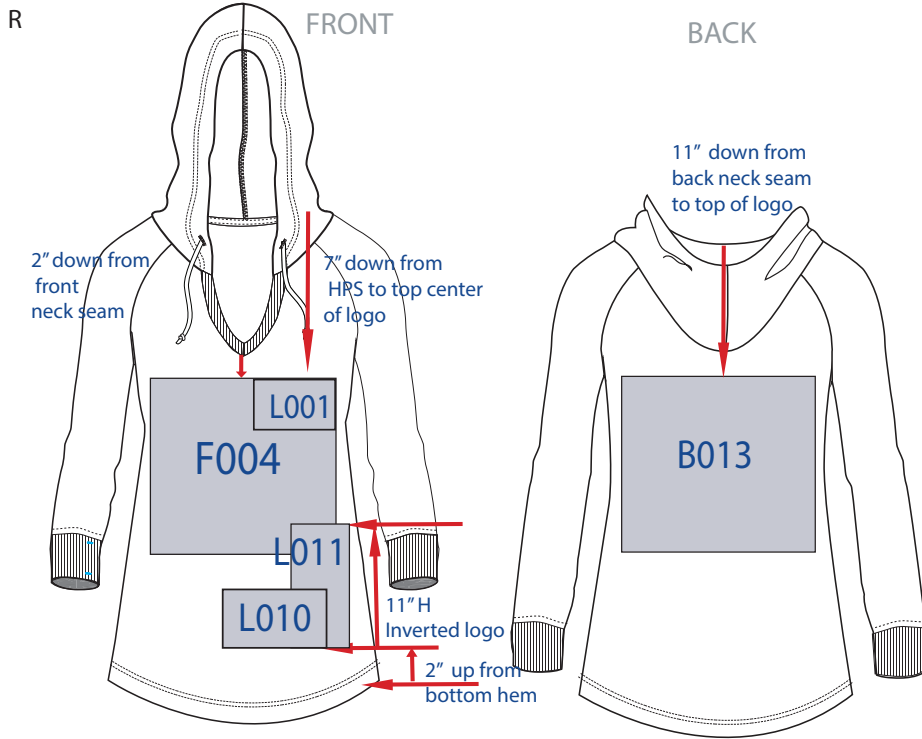

INFORMATION

*Available in:
 Adult XS - 3X
 Plus 1XP - 4XP

- * 5.9 oz. 80/17/3 Viscose/Polyester/Elastane Cuddle Knit (Exclusive of decoration)
- * Rib front neck band and sleeve cuffs
- * Mitered neck
- * Self drawcords finished w/knot
- * Shirt tail hem
- * Raglan sleeves
- * Waist shaping for feminine fit

SPECIAL INSTRUCTIONS

Screenprint & Embroidery
 * No small detail or distressed art on left chest

F004 FRONT CENTER

PLUS : 12W x 12H MAX
 ADULT : 9W x 9H MAX
 PLACEMENT : Centered 2" from neck seam to top of logo

L001 LEFT CHEST

ADULT : 3W x 3H MAX
 PLACEMENT : 7" down from High Point Shoulder point

L010 SHIRT HEM

ADULT : 4W x 4H MAX
 PLACEMENT : 2" up from bottom hem to bottom of logo

B013 BACK CENTER

PLUS : 12W x 12H MAX
 ADULT : 10W x 10H MAX
 PLACEMENT : 2"-4" down from neck seam to top of logo

AVAILABLE PROCESSES:

- S
- S E
- S
- S

R

L

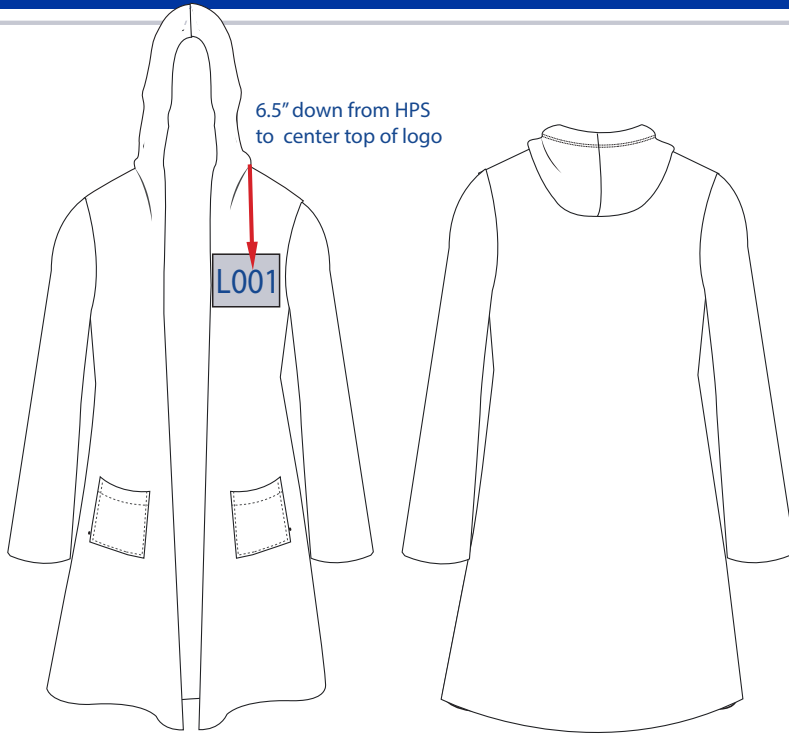

FRONT

BACK

INFORMATION

- * Available in:
Adult XS - 3X
- * 5.9 oz. 80/17/3 Viscose/Poly/
Elastane Brushed Hacci Knit
(Exclusive of decoration)
- * Hood
- * Front Pockets
- * Side Vent along side seam

SPECIAL INSTRUCTIONS

- * Screen print & embroidery
- * No small detail or distressed
art on left chest

L001 LEFT CHEST

ADULT : 3W x3H MAX
PLACEMENT : 6.5" down from HPS to top of logo

AVAILABLE PROCESSES:



R

FRONT

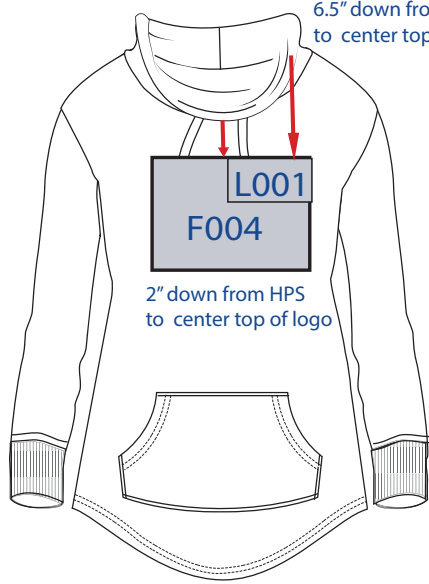

6.5" down from HPS to center top of logo

2" down from HPS to center top of logo

BACK

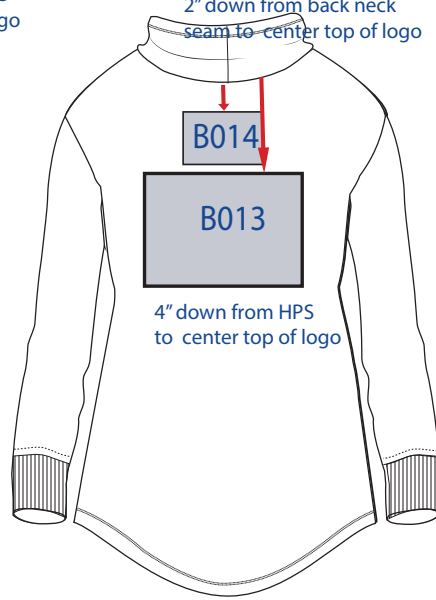

2" down from back neck seam to center top of logo

4" down from HPS to center top of logo

L

INFORMATION

*Available in:
Adult XS - 3X

- * 5.9 oz. 80/17/3 Viscose/Poly/Elastane Brushed Hacci Knit (Exclusive of Decoration)
- * Cowl neck with twill drawcord
- * Rib cuffs with thumb holes
- * Kangaroo pocket
- * Shirtail hem

SPECIAL INSTRUCTIONS

- * Screen print & Embroidery
- * No small detail or distressed art on left chest

L001 LEFT CHEST

ADULT : 3W x 3H MAX
PLACEMENT : 6.5" down from HPS to top of logo

F004 FRONT CENTER

ADULT : 9W x 9H MAX
PLACEMENT : 2" down from center neck seam to top of logo

B013 BACK CENTER

ADULT : 10W x 10H MAX
PLACEMENT : 4" down from center neck seam to top of logo

B014 UPPER BACK CENTER

ADULT : 3W x 3H MAX
PLACEMENT : 4" down from center neck seam to top of logo

AVAILABLE PROCESSES:

S E

S

S

S

R

L

INFORMATION

- * Available in:
 - Adult XS - 3X
- * 8.3 oz. 70/30 Cotton/ Poly French Terry (Exclusive of decoration)
- * Self-Hood
- * Drawcords
- * Stripe bottom band and sleeve cuffs
- * Cropped fit

SPECIAL INSTRUCTIONS

- * Screen print only
- * No small detail or distressed art on left chest

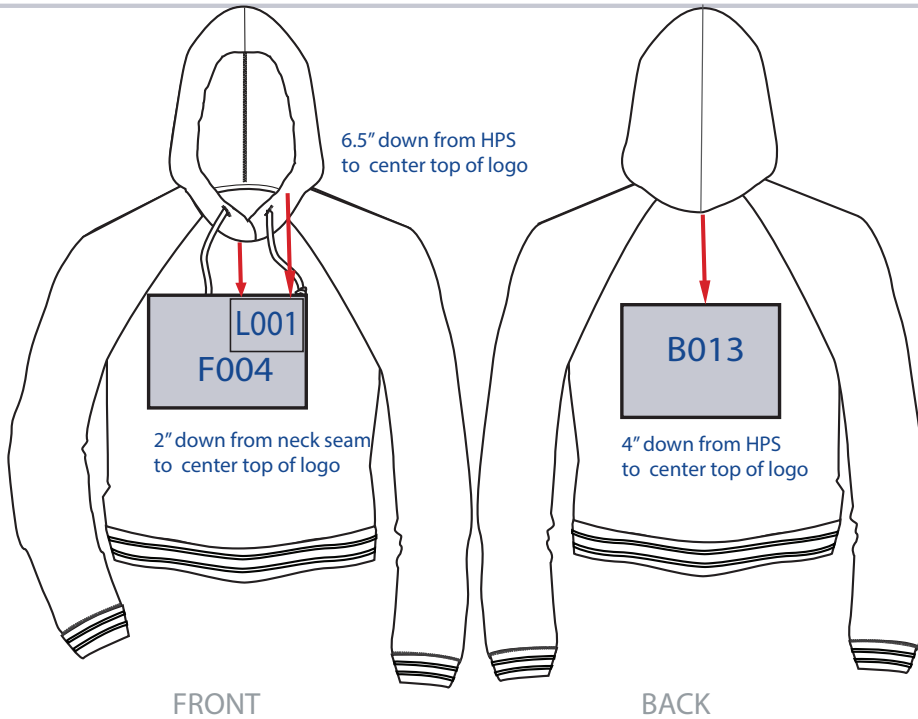

FRONT

BACK

L001 LEFT CHEST

ADULT : 3W x 3H MAX
 PLACEMENT : 6.5" down from HPS to top of logo

F004 FRONT CENTER

ADULT : 9W x 9H MAX
 PLACEMENT : 2" down from center neck seam to top of logo

B013 BACK CENTER

ADULT : 9W x 9H MAX
 PLACEMENT : 4" down from bottom of the neck seam to top center of logo

AVAILABLE PROCESSES:



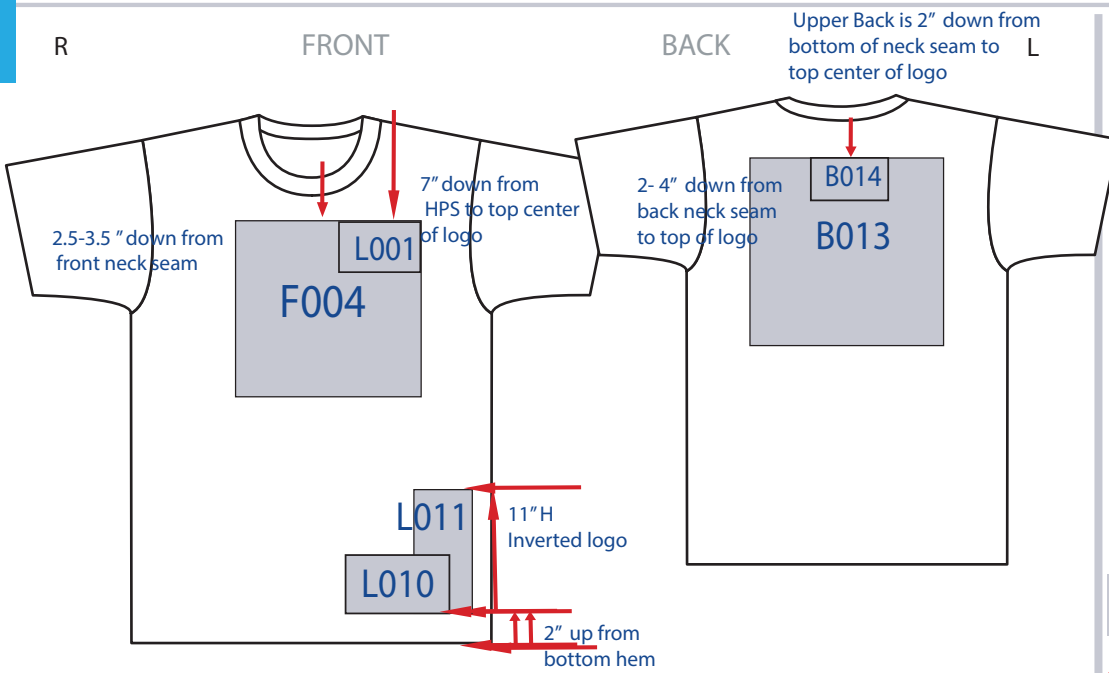

INFORMATION

- * Available in:
 - Adult S- 2X
 - Youth YS - YL
- * Unisex Athletic Fit
- * 4 oz. 100% Ringspun Cotton
- * Available in Screen Print
- * 17 Colors

SPECIAL INSTRUCTIONS

- * Screen print only
- * No small detail or distressed art on left chest

F004 FRONT CENTER

ADULT : 12W x 12H MAX
 PLACEMENT : Centered 2.5" - 3.5" from neck seam to top of logo

YOUTH: 10W x 10H MAX
 PLACEMENT : Centered 1.5" - 2.5" from neck seam to top of logo

L001 LEFT CHEST

ADULT : 3W x 3H MAX
 PLACEMENT : 7" down from High Point Shoulder point

YOUTH: 2W x 2H MAX
 PLACEMENT : 6" down from High Point Shoulder point

L010 SHIRT HEM

ADULT : 4W x 4H MAX
 PLACEMENT : 2" up from bottom hem to bottom of logo

YOUTH: 3W x 3H MAX
 PLACEMENT : 2" up from bottom hem to bottom of logo

B013 BACK CENTER

ADULT : 14W x 12H MAX
 PLACEMENT : 2"-4" down from neck seam to top of logo

YOUTH: 12W x 10H MAX
 PLACEMENT : 2"-4" down from neck seam to top of logo

L011 INVERTED HEM

ADULT : 3W x 11H MAX
 PLACEMENT : 2"-4" down from bottom hem to bottom of logo

YOUTH: 2W x 8H MAX
 PLACEMENT : 2"-4" down from bottom hem to bottom of logo

B014 UPPER BACK CENTER

ADULT : 3W x 3H MAX
 PLACEMENT : 2"-4" down from neck seam to top of logo

YOUTH: 2W x 2H MAX
 PLACEMENT : 2"-4" down from neck seam to top of logo

AVAILABLE PROCESSES:



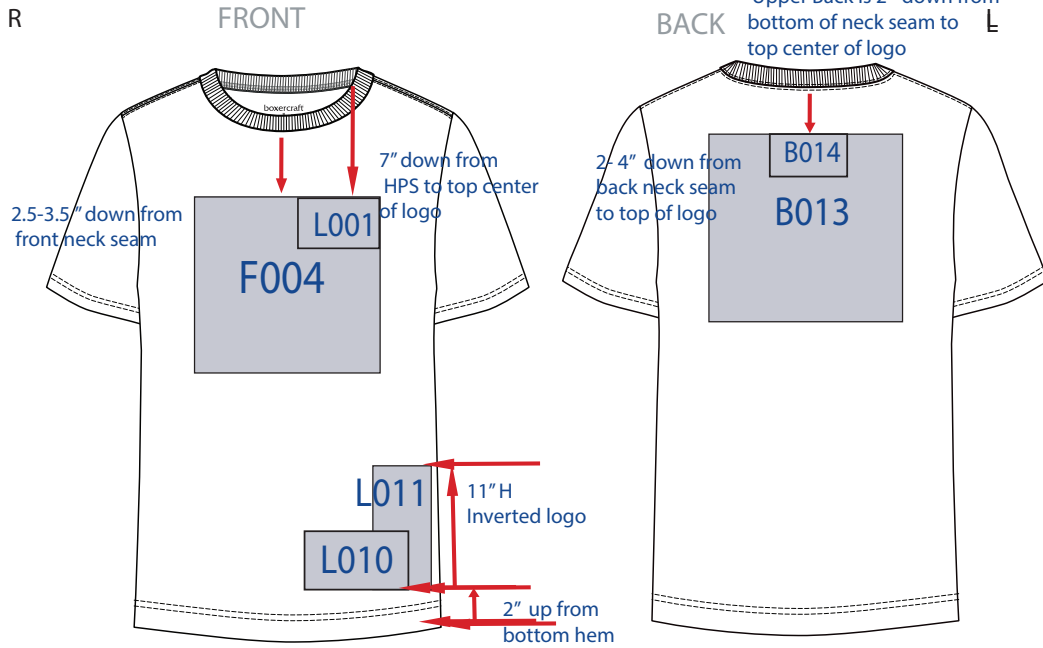

INFORMATION

*Available in:
 Adult XS - 2X
 Youth YS-YL

* 5.3 Oz. 100% cotton pigment dyed jersey (exclusive of decoration)
 * Taped back neck ribbed collar
 * Double-needle hem sleeves
 (Allow for color variation in production & washing due to pigment dye for this process)

SPECIAL INSTRUCTIONS

* Screen print only
 * No small detail or distressed art on left chest

F004 FRONT CENTER

ADULT : 12W x 12H MAX
 PLACEMENT : Centered 2.5" - 3.5" from neck seam to top of logo

YOUTH: 10W x 10H MAX
 PLACEMENT : Centered 1.5" - 2.5" from neck seam to top of logo

L001 LEFT CHEST

ADULT : 3W x 3H MAX
 PLACEMENT : 7" down from High Point Shoulder point

YOUTH: 2W x 2H MAX
 PLACEMENT : 6" down from High Point Shoulder point

L010 SHIRT HEM

ADULT : 4W x 4H MAX
 PLACEMENT : 2" up from bottom hem to bottom of logo

YOUTH: 3W x 3H MAX
 PLACEMENT : 2" up from bottom hem to bottom of logo

B013 BACK CENTER

ADULT : 14W x 12H MAX
 PLACEMENT : 2"-4" down from neck seam to top of logo

YOUTH: 12W x 10H MAX
 PLACEMENT : 2"-4" down from neck seam to top of logo

L011 INVERTED HEM

ADULT : 3W x 11H MAX
 PLACEMENT : 2"-4" down from bottom hem to bottom of logo

YOUTH: 2W x 8H MAX
 PLACEMENT : 2"-4" down from bottom hem to bottom of logo

B014 UPPER BACK CENTER

ADULT : 3W x 3H MAX
 PLACEMENT : 2"-4" down from neck seam to top of logo

YOUTH: 2W x 2H MAX
 PLACEMENT : 2"-4" down from neck seam to top of logo

AVAILABLE PROCESSES:



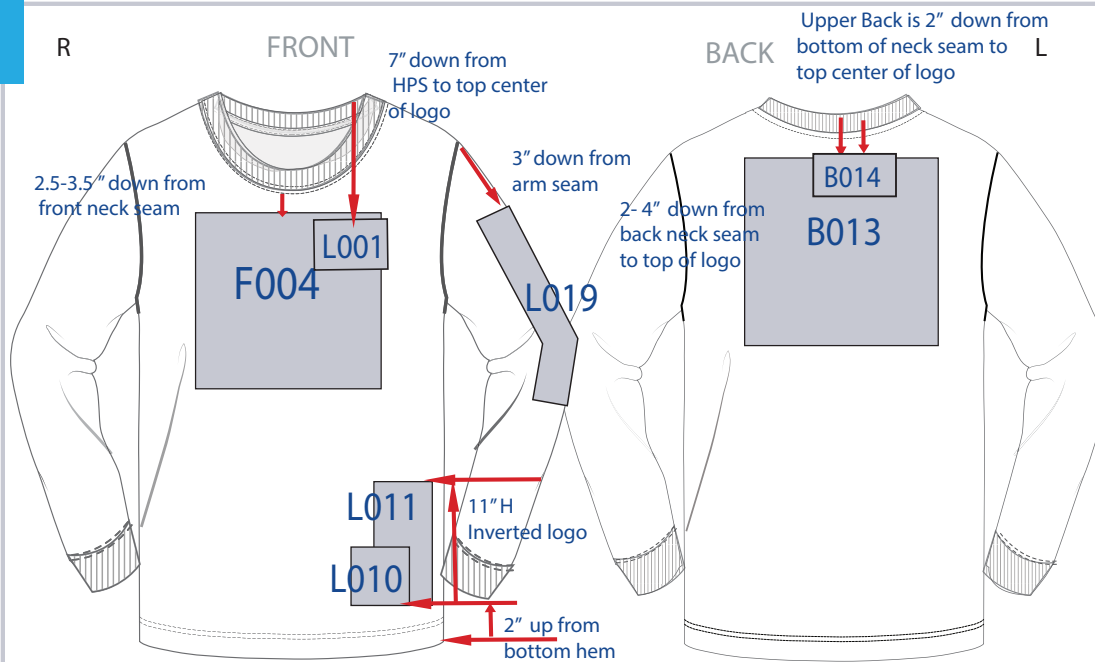

INFORMATION

*Available in:

Adult XS - 2X
Youth YS-YL

* 5.3 Oz. 100% cotton pigment dyed jersey (exclusive of decoration)

* Rib neckband and sleeve cuffs (Allow for color variation in production & washing due to pigment dye for this process)

SPECIAL INSTRUCTIONS

Screen print & Embroidery
*no small details or distressed art for left chest or upper back center placements

F004 FRONT CENTER

ADULT: 12W x 12H MAX
PLACEMENT: Centered 2.5" - 3.5" from neck seam to top of logo

YOUTH: 10W x 10H MAX
PLACEMENT: Centered 1.5" - 2.5" from neck seam to top of logo

L001 LEFT CHEST

ADULT: 3W x 3H MAX
PLACEMENT: 7" down from High Point Shoulder point

YOUTH: 2W x 2H MAX
PLACEMENT: 6" down from High Point Shoulder point

L010 SHIRT HEM

ADULT: 4W x 4H MAX
PLACEMENT: 2" up from bottom hem to bottom of logo

YOUTH: 3W x 3H MAX
PLACEMENT: 2" up from bottom hem to bottom of logo

L011 LOWER INVERTED HEM

ADULT: 3W x 11H MAX
PLACEMENT: 2" up from bottom hem to edge of logo (Inverted Art)

YOUTH: 2W x 8H MAX
PLACEMENT: 2" up from bottom hem to edge of logo (inverted art)

B013 BACK CENTER

ADULT: 14W x 12H MAX
PLACEMENT: 2"-4" down from neck seam to top of logo

YOUTH: 12W x 10H MAX
PLACEMENT: 2"-4" down from neck seam to top of logo

B014 UPPER BACK CENTER

ADULT: 3W x 3H MAX
PLACEMENT: 2"-4" down from neck seam to top of logo

YOUTH: 2W x 2H MAX
PLACEMENT: 2" down from bottom center neck seam centered on back neck

L019 FULL SLEEVE

ADULT: 3W x 12H MAX
PLACEMENT: 3.5" down from arm seam

YOUTH: 2W x 10H MAX
PLACEMENT: 2.5" down from arm seam

AVAILABLE PROCESSES:

S

S E

S

S

S

S E

S

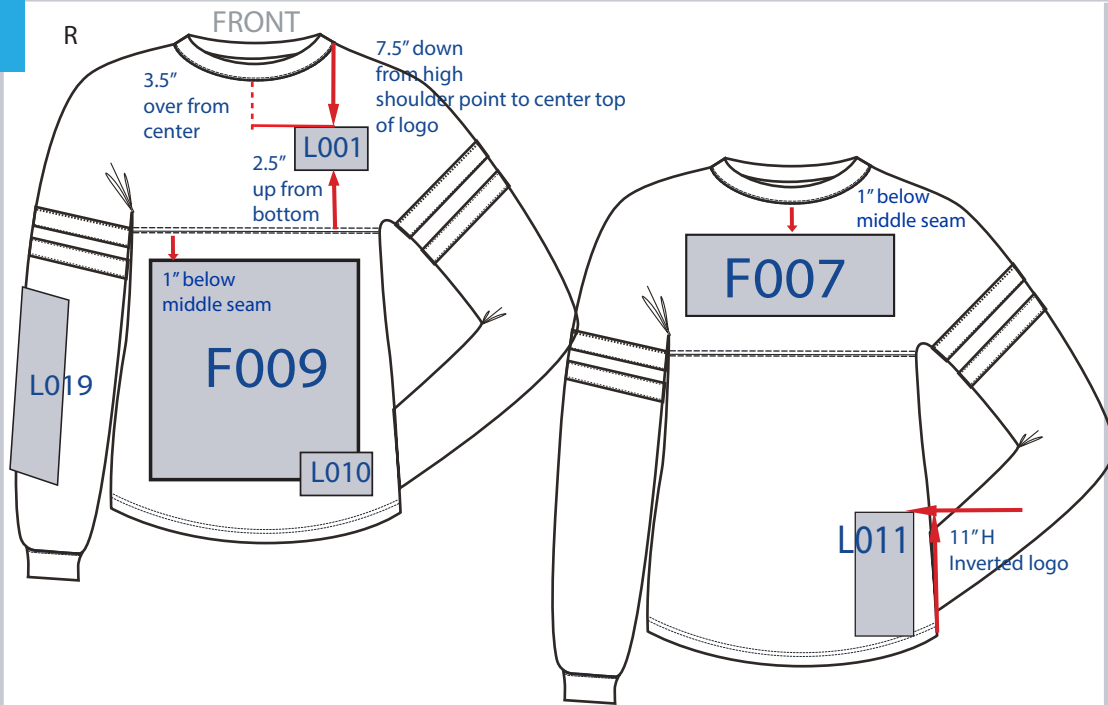

INFORMATION

- * Available in:
 - Adult XS - 2X
 - Youth YS - YL
- * UNISEX FIT
- * 6.6 oz 100% Cotton Jersey
- * Roomy Oversize Fit
- * Double Athletic Stripes on Sleeves
- * Screen Print and Embroidery & No small detail or distressed art

SPECIAL INSTRUCTIONS

- ** No More Than 4 Color Ink Available For 1 Graphic
- ** Puff Print Available

L001 LEFT CHEST

ADULT : 3W x 3H MAX
 PLACEMENT : Measure 7.5" down from HPS to top of logo
 3.5" down from center point "V" to top of logo
 2.5" up from bottom of chest seam to bottom of logo

YOUTH : 3W x 3H MAX
 PLACEMENT : Measure 6.5" down from HPS to top of logo
 2.5" down from center point "V" to top of logo
 1.5" up from bottom of chest seam to bottom of logo

L010 SHIRT HEM

ADULT: 4W x 4H MAX
 PLACEMENT: 2" up from bottom hem
 YOUTH: 3W x 3H MAX

L011 INVERTED HEM

ADULT : 3W x 11H MAX
 PLACEMENT : 2"- 4" down from bottom hem to bottom of logo

YOUTH: 2W x 8H MAX

F007 UPPER FRONT

ADULT : 14W x 5H MAX
 PLACEMENT : 2"- 4" down from bottom hem to bottom of logo

YOUTH: 12W x 4H MAX
 PLACEMENT : 2"- 4" down from bottom hem to bottom of logo

L019 FULL SLEEVE

ADULT : 3W x 10H MAX
 PLACEMENT : Centered on the side of the sleeve
 YOUTH : 3W x 6H MAX

F009 LOWER FRONT

ADULT : 14W x 12H MAX
 PLACEMENT : 1" below the seam that runs in the middle of the garment
 YOUTH : 12W x 7H MAX
 PLACEMENT : 1" below the seam that runs in the middle of the garment

AVAILABLE PROCESSES:

- S** **E**
- S**
- S**
- S**
- S**

R

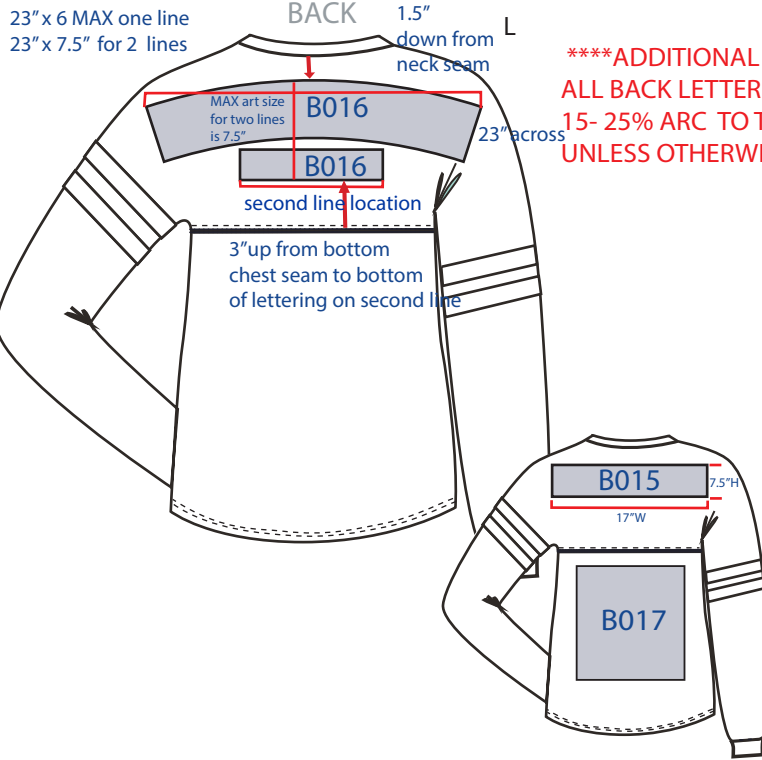

**** ADDITIONAL NOTE:
ALL BACK LETTERING PRINTS WILL HAVE A STANDARD 15- 25% ARC TO THE GRAPHIC PER ARTIST DISCRETION UNLESS OTHERWISE NOTED BY CUSTOMER

**Fonts offered in Puff Print:
COLLEGE
COPPERPLATE
IMPACT
SKETCH BLOCK
Wisdom Script

PRODUCTION:
YOUTH OS back prints MUST print on a press with YOUTH pallets

AVAILABLE PROCESSES:

B016 OVERSIZED UPPER BACK

ADULT: ONE LINE: 23" W x 6" H MAX SIZE FOR ONE LINE
TWO LINES: 23" W x 7.5" H MAX SIZE FROM TOP OF FIRST LINE TO BOTTOM OF SECOND LINE

SECOND LINE WIDTH IS 10" across under arc lettering

PLACEMENT: 1.5" down from bottom of back center seam to top of arc lettering
3" up from bottom of chest seam to bottom of second line lettering

YOUTH: ONE LINE: 20" W x 4" H MAX FOR ONE LINE
TWO LINES: 20" W x 5.5" H MAX FROM TOP OF FIRST LINE TO BOTTOM OF SECOND LINE

**NOTE: When orders contain a YOUTH XS or S, art can only be maxed to 19" W x 4" H

B015 UPPER BACK

ADULT: 17" W x 7.5" H MAX
PLACEMENT: Centered 2" - 4" up from bottom neck seam
YOUTH: 12" W x 5.5" H MAX

B017 LOWER BACK

ADULT: 14" W x 12" H MAX
PLACEMENT: 1" below the seam that runs in the middle of the garment
YOUTH: 12" W x 7" H MAX
PLACEMENT: 1" below the seam that runs in the middle of the garment

S

S

S

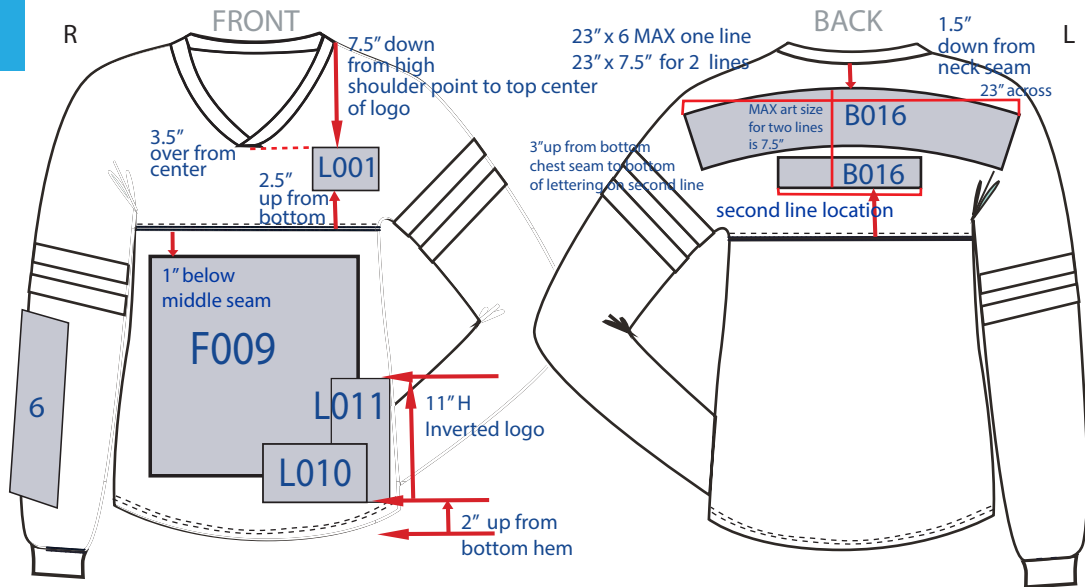

INFORMATION

- * Available in:
 - Adult XS - 2X
 - Youth YS - YL
- * Womens Fit / V Neck
- * 3.5oz 60/40 Cotton/ Poly Slub Jersey
- * Sleeve Stripes are Always White
- * Screen Print ONLY

SPECIAL INSTRUCTIONS

- * No More Than 4 Color Ink Offered For 1 Graphic
- ** We Suggest Distress Printing Will Look Best on This Fabric

**** ADDITIONAL NOTE:
 ALL BACK LETTERING PRINTS WILL HAVE A STANDARD 15- 25% ARC TO THE GRAPHIC PER ARTIST DISCRETION UNLESS OTHERWISE NOTED BY CUSTOMER

L001 LEFT CHEST

ADULT : 3W x 3H MAX
 PLACEMENT : Measure 7.5" down from HPS to top of logo
 3.5" down from center point "V" to top of logo
 2.5" up from bottom of chest seam to bottom of logo

YOUTH : 3W x 3H MAX
 PLACEMENT : Measure 6.5" down from HPS to top of logo
 2.5" down from center point "V" to top of logo
 1.5" up from bottom of chest seam to bottom of logo

L010 SHIRT HEM

ADULT: 4W x 4H MAX
 PLACEMENT: 2" up from bottom hem

YOUTH: 3W x 3H MAX PLACEMENT: 2" up from bottom hem

B016 OVERSIZED UPPER BACK

ADULT: ONE LINE: 23" W x 6" H MAX SIZE FOR ONE LINE
 TWO LINES: 23" W x 7.5" H MAX FROM TOP OF FIRST LINE TO BOTTOM OF SECOND LINE
 SECOND LINE WIDTH IS 10" across under arc lettering

PLACEMENT: 1.5" down from bottom of back center seam to top of arc lettering 3" up from bottom of chest seam to bottom of second line lettering

YOUTH: ONE LINE : 20" W x 4" H MAX FOR ONE LINE
 TWO LINES: 20" W x 5.5" H MAX FROM TOP OF FIRST LINE TO BOTTOM OF SECOND LINE

**NOTE: When orders contain a YOUTH XS or S, art can only be maxed to 19" W x 4" H

B015 UPPER BACK

ADULT: 17" W x 7.5" H
 PLACEMENT: Centered 2" - 4" up from bottom neck seam

YOUTH: 12W x 5.5H MAX

F009 LOWERFRONT

ADULT : 14W x 12H MAX
 PLACEMENT : 1" below the seam that runs in the middle of the garment

YOUTH : 12W x 7H MAX
 PLACEMENT : 1" below the seam that runs in the middle of the garment

B017 LOWER BACK

L019 FULL SLEEVE

ADULT : 3W x 10H MAX
 PLACEMENT : Centered on the side of the sleeve

YOUTH : 3W x 6H MAX

AVAILABLE PROCESSES:

S E

S

S

S

S

S

R

INFORMATION

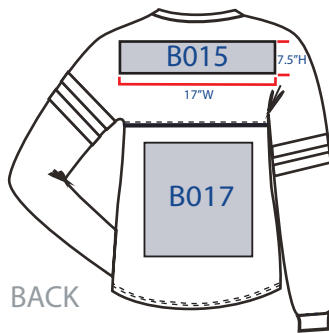

BACK

- * Screen print only
- * No small detail or distressed art on left chest

PRODUCTION:
 YOUTH OS back prints **MUST**
 print on a press with **YOUTH**
 pallets

L011 INVERTED HEM

ADULT : 3W x 11H MAX
 PLACEMENT : 2" - 4" down from bottom hem to bottom of logo

YOUTH : 2W x 8H MAX
 PLACEMENT : 2" - 4" down from bottom hem to bottom of logo

F007 UPPER FRONT

ADULT : 14W x 5H MAX
 PLACEMENT : 2" - 4" down from bottom hem to bottom of logo

YOUTH : 12W x 4H MAX
 PLACEMENT : 2" - 4" down from bottom hem to bottom of logo

AVAILABLE PROCESSES:



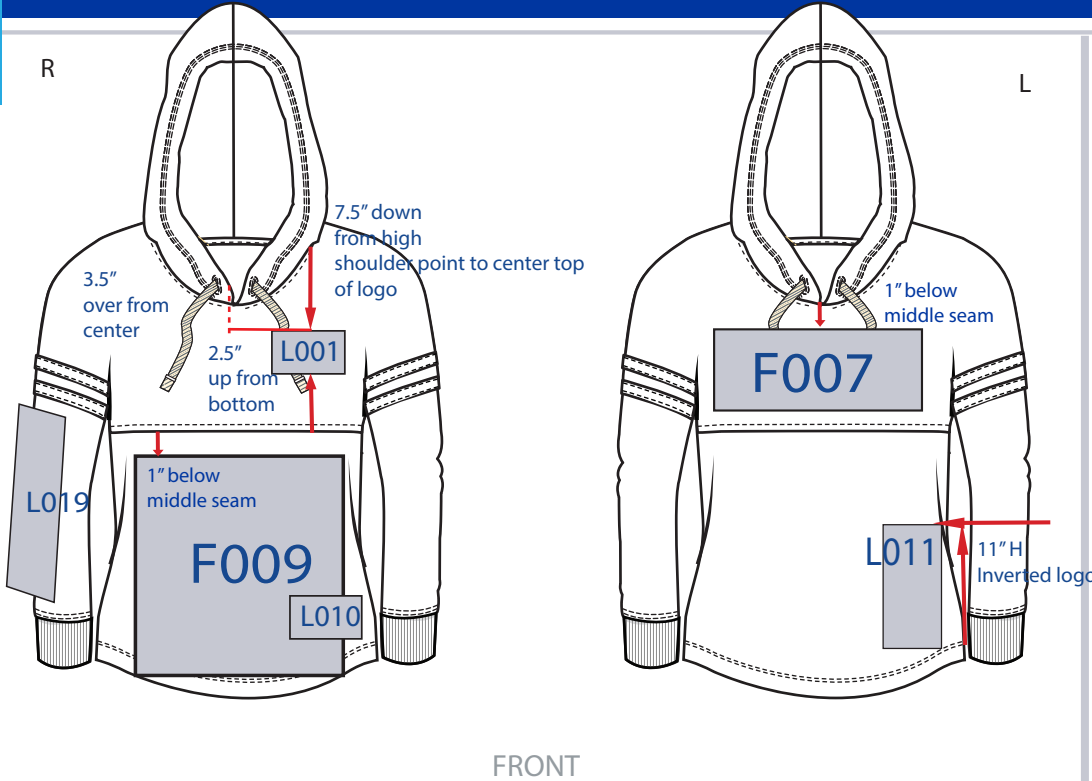

INFORMATION

- *Available in:
 - Adult XS - 2X
 - Youth YS- YL
- * UNISEX FIT
- * 6.6 oz 100% Cotton Jersey
- * Roomy Oversize Fit
- * Top half is always granite
- * Bottom and stripes match in a variety of colors
- * Screen Print and Embroidery & No small detail or distressed art

SPECIAL INSTRUCTIONS

- ** Puff Print Available
- ** No More Than 4 Color Ink Available For 1 Graphic

FRONT

L001 LEFT CHEST

ADULT : 3W x 3H MAX
 PLACEMENT : Measure 7.5" down from HPS to top of logo
 3.5" down from center point "V" to top of logo
 2.5" up from bottom of chest seam to bottom of logo

YOUTH : 3W x 3H MAX
 PLACEMENT : Measure 6.5" down from HPS to top of logo
 2.5" down from center point "V" to top of logo
 1.5" up from bottom of chest seam to bottom of logo

L011 INVERTED HEM

ADULT : 3W x 11H MAX
 PLACEMENT : 2"- 4" down from bottom hem to bottom of logo

YOUTH : 2W x 8H MAX

F007 UPPER FRONT

ADULT : 14W x 5H MAX
 PLACEMENT : 2"- 4" down from bottom hem to bottom of logo

YOUTH : 12W x 4H MAX
 PLACEMENT : 2"- 4" down from bottom hem to bottom of logo

L010 SHIRT HEM

ADULT : 4W x 4H
 PLACEMENT : 2" up from bottom hem

YOUTH : 3W x 3H
 PLACEMENT : 2" up from bottom hem

L019 FULL SLEEVE

ADULT : 3W x 10H MAX
 PLACEMENT : Centered on the side of the sleeve

YOUTH : 3W x 6H MAX

F009 LOWER FRONT

ADULT : 14W x 12H MAX
 PLACEMENT : 1" below the seam that runs in the middle of the garment

YOUTH : 12W x 7H MAX
 PLACEMENT : 1" below the seam that runs in the middle of the garment

AVAILABLE PROCESSES:



R

23" x 6 MAX one line
23" x 7.5" for 2 lines

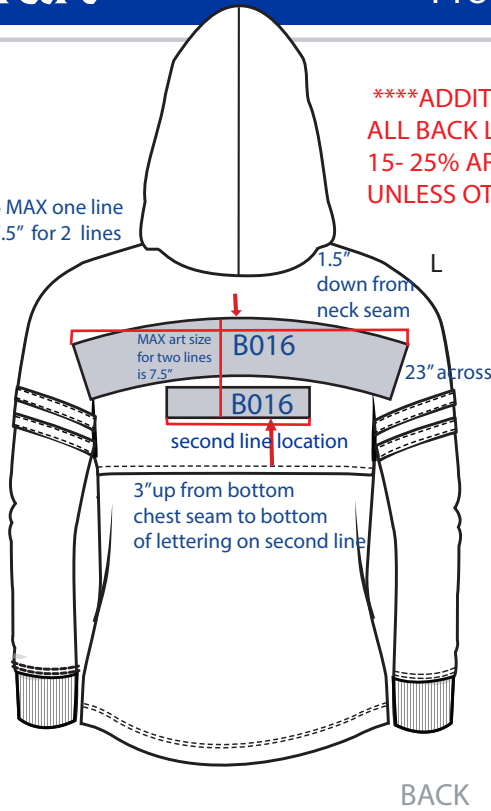

****ADDITIONAL NOTE:
ALL BACK LETTERING PRINTS WILL HAVE A STANDARD
15- 25% ARC TO THE GRAPHIC PER ARTIST DISCRETION
UNLESS OTHERWISE NOTED BY CUSTOMER

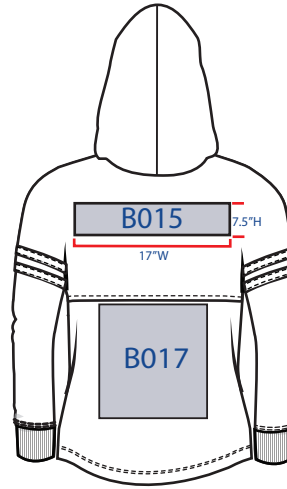

****Fonts offered in Puff Print:**
COLLEGE
COPPERPLATE
IMPACT
SKETCH BLOCK
Wisdom Script

PRODUCTION:
YOUTH OS back prints **MUST**
print on a press with YOUTH
pallets

BACK

AVAILABLE PROCESSES:

B016 OVERSIZED UPPER BACK

ADULT: ONE LINE: 23" W x 6" H MAX SIZE FOR ONE LINE
TWO LINES: 23" W x 7.5" MAX SIZE FROM TOP OF FIRST LINE
TO BOTTOM OF SECOND LINE
SECOND LINE WIDTH IS 10" across under arc lettering
PLACEMENT: 1.5" down from bottom of back center seam to top of arc
lettering 3" up from bottom of chest seam to bottom of second line lettering

YOUTH: ONE LINE: 20" W x 4" H MAX FOR ONE LINE
TWO LINES: 20" W x 5.5" H MAX FROM TOP OF FIRST
LINE TO BOTTOM OF SECOND LINE

****NOTE:** When orders contain a YOUTH XS or S, art can only be maxed to 19" W x 4" H

B015 UPPER BACK

ADULT: 17" W x 7.5" H MAX
PLACEMENT: Centered 2" - 4" up from bottom neck seam
YOUTH: 12W x 5.5H MAX

B017 LOWER BACK/

ADULT: 14W x 12H MAX
PLACEMENT: 1" below the seam that runs in the middle
of the garment
YOUTH: 12W x 7H MAX
PLACEMENT: 1" below the seam that runs in the middle
of the garment

S

S

S

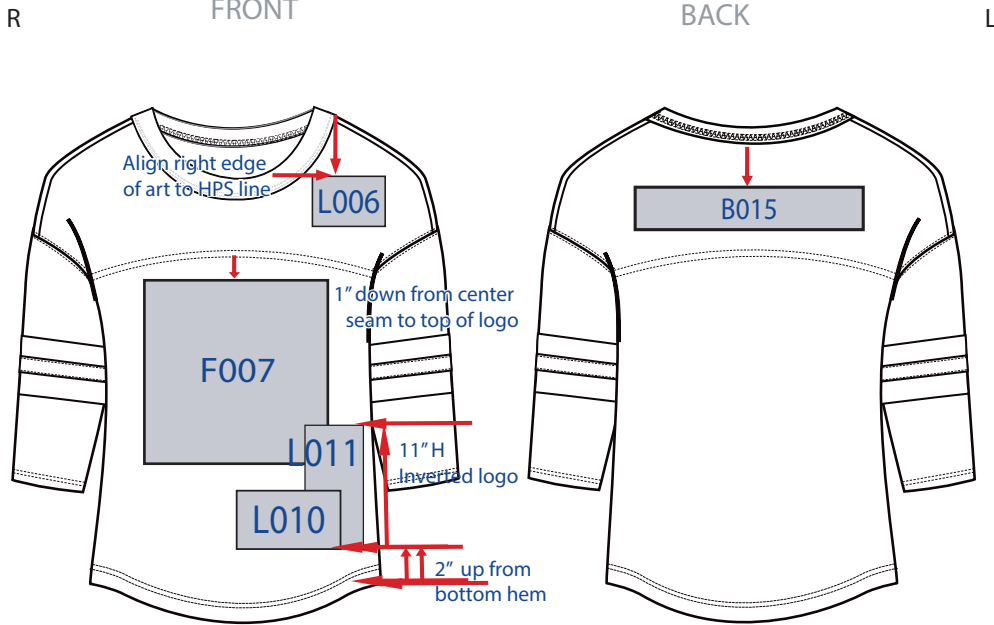

* Screen print only
* No small detail or distressed art on left chest

INFORMATION

- *Available in: Adult XS - 2X
- *5.3oz., 100% cotton jersey
- *Oversized ladies fit tee
- *3/4-length sleeves
- *Dyed to match sleeve stripes
- *Front and back yoke seam
- *Pigment dyed for vintage and worn look

SPECIAL INSTRUCTIONS

- *ARTIST NOTE:
- White shirt= no under base
- Colored shirt w/ white ink= 1 gray under base
- Colored shirt w/ colored ink= 1 white & 1 gray under base

AVAILABLE PROCESSES:

L006 HIGH CHEST ADULT: 3W x 3H MAX
PLACEMENT: 2" down from HPS to top of logo; Align right edge of art to HPS line

S E

F007 LOWER FRONT ADULT: 14W x 12H MAX
PLACEMENT: 1" down from center seam to top of logo

S

L010 SHIRT HEM ADULT: 4W x 4H MAX
PLACEMENT: 2" up from bottom hem to bottom of logo

S

L011 INVERTED HEM ADULT: 3W x 11H MAX
PLACEMENT: 2"-4" down from bottom hem to bottom of logo

S

B015 UPPER BACK ADULT: 14"W x 3"H
PLACEMENT: Centered 2"-4" up from bottom neck seam

S

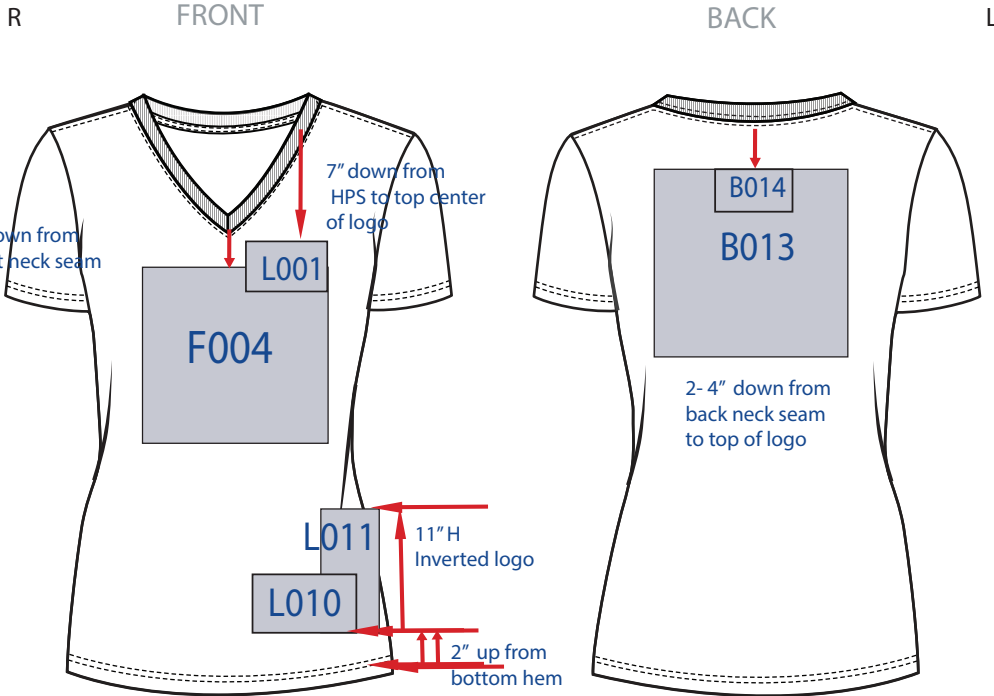

INFORMATION

- * Available in:
 - Adult S- 2X
 - Youth YS - YL
- * Ladies
- * Triblend
- * Rib Trim on Neck

SPECIAL INSTRUCTIONS

- * Screen print only
- * No small detail or distressed art on left chest

F004 FRONT CENTER

ADULT : 9W x 9H MAX
 PLACEMENT : Centered 2" from neck seam to top of logo

YOUTH: 7W x 7H MAX
 PLACEMENT : Centered 2" from neck seam to top of logo

L001 LEFT CHEST

ADULT : 3W x 3H MAX
 PLACEMENT : 7" down from High Point Shoulder point

YOUTH: 2W x 2H MAX
 PLACEMENT : 6" down from High Point Shoulder point

L010 SHIRT HEM

ADULT : 4W x 4H MAX
 PLACEMENT : 2" up from bottom hem to bottom of logo

YOUTH: 3W x 3H MAX
 PLACEMENT : 2" up from bottom hem to bottom of logo

B013 BACK CENTER

ADULT : 10W x 10H MAX
 PLACEMENT : 2"-4" down from neck seam to top of logo

YOUTH: 8W x 8H MAX
 PLACEMENT : 2"-4" down from neck seam to top of logo

L011 INVERTED HEM

ADULT : 3W x 11H MAX
 PLACEMENT : 2"-4" down from bottom hem to bottom of logo

YOUTH: 2W x 8H MAX
 PLACEMENT : 2"-4" down from bottom hem to bottom of logo

B014 UPPER BACK CENTER

ADULT : 3W x 3H MAX
 PLACEMENT : 2"-4" down from neck seam to top of logo

YOUTH: 2W x 2H MAX
 PLACEMENT : 2"-4" down from neck seam to top of logo

AVAILABLE PROCESSES:



R FRONT

BACK L

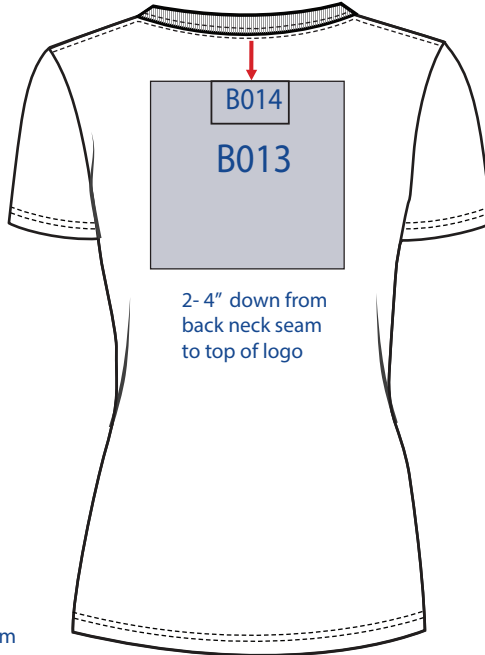
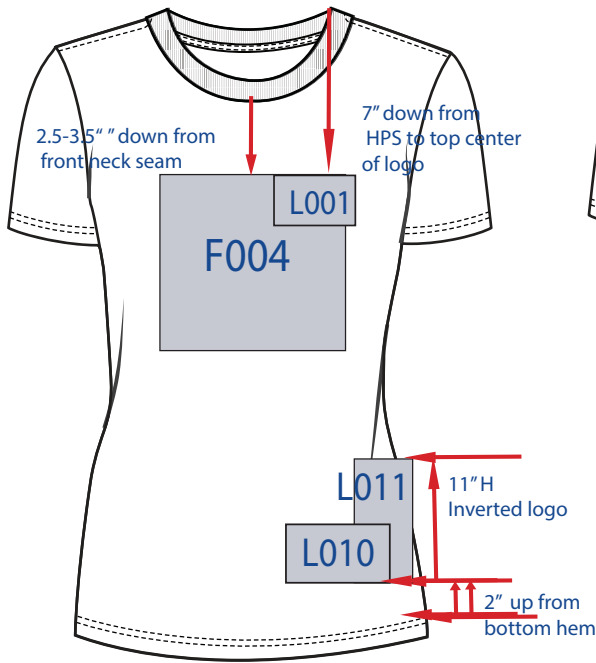

INFORMATION

- *Available in:
 - Adult S- 2X
 - Youth YS - YL
- * Ladies
- * Triblend
- * Rib Trim on Neck

SPECIAL INSTRUCTIONS

- * PRINT OPTIONS:
- DTG PRESS AVAILABLE

SPECIAL INSTRUCTIONS

- * Screen print only
- * No small detail or distressed art on left chest

F004 FRONT CENTER

ADULT : 9W x 9H MAX
 PLACEMENT : Centered 2.5"-3.5" down from neck seam to top of logo

YOUTH: 7W x 7H MAX
 PLACEMENT : Centered 2.5"-3.5" down from neck seam to top of logo

L001 LEFT CHEST

ADULT : 3W x 3H MAX
 PLACEMENT : 7" down from High Point Shoulder point

YOUTH: 2W x 2H MAX
 PLACEMENT : 6" down from High Point Shoulder point

L010 SHIRT HEM

ADULT : 4W x 4H MAX
 PLACEMENT : 2" up from bottom hem to bottom of logo

YOUTH: 3W x 3H MAX
 PLACEMENT : 2" up from bottom hem to bottom of logo

B013 BACK CENTER

ADULT : 10W x 10H MAX
 PLACEMENT : 2"-4" down from neck seam to top of logo

YOUTH: 8W x 8H MAX
 PLACEMENT : 2"-4" down from neck seam to top of logo

L011 INVERTED HEM

ADULT : 3W x 11H MAX
 PLACEMENT : 2"-4" down from bottom hem to bottom of logo

YOUTH: 2W x 8H MAX
 PLACEMENT : 2"-4" down from bottom hem to bottom of logo

B014 UPPER BACK CENTER

ADULT : 3W x 3H MAX
 PLACEMENT : 2"-4" down from neck seam to top of logo

YOUTH: 2W x 2H MAX
 PLACEMENT : 2"-4" down from neck seam to top of logo

AVAILABLE PROCESSES:



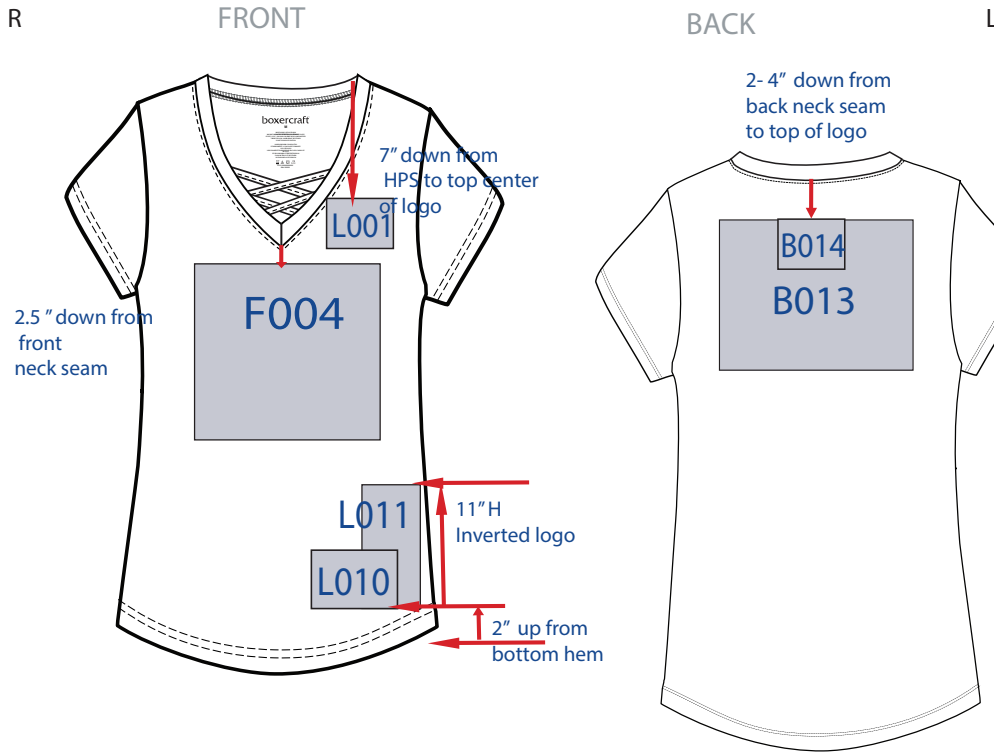

INFORMATION

- * Available in:
 - Adult XS - 3X
 - Plus 1XP- 4XP
 - Youth YS - YL
- * 3.5 oz. 60/40 Cotton/ Poly Jersey Slub
- * Bottom Hem Lightweight 100% Polyester Crepe
- * Short Sleeves Lightweight Printed Crepe Hem
- * Side Vents

SPECIAL INSTRUCTIONS

- * Screen print only
- * No small detail or distressed art on left chest

F004 FRONT CENTER	PLUS : 12W x 12H MAX ADULT : 9W x 9H MAX PLACEMENT : Centered 2.5" - 3.5" from neck seam to top of logo YOUTH: 7W x 7H MAX PLACEMENT : Centered 1.5" - 2.5" from neck seam to top of logo
L001 LEFT CHEST	ADULT : 3W x 3H MAX PLACEMENT : 7" down from High Point Shoulder point YOUTH: 2W x 2H MAX PLACEMENT : 6" down from High Point Shoulder point
L010 SHIRT HEM	ADULT : 4W x 4H MAX PLACEMENT : 2" up from bottom hem to bottom of logo YOUTH: 3W x 3H MAX PLACEMENT : 2" up from bottom hem to bottom of logo
B013 BACK CENTER	PLUS : 12W x 12H MAX ADULT : 10W x 10H MAX PLACEMENT : 2"-4" down from neck seam to top of logo YOUTH: 8W x 8H MAX PLACEMENT : 2"-4" down from neck seam to top of logo
L011 INVERTED HEM	ADULT : 3W x 11H MAX PLACEMENT : 2"-4" down from bottom hem to bottom of logo YOUTH: 2W x 8H MAX PLACEMENT : 2"-4" down from bottom hem to bottom of logo
B014 UPPER BACK CENTER	ADULT : 3W x 3H MAX PLACEMENT : 2"-4" down from neck seam to top of logo YOUTH: 2W x 2H MAX PLACEMENT : 2"-4" down from neck seam to top of logo

AVAILABLE PROCESSES:



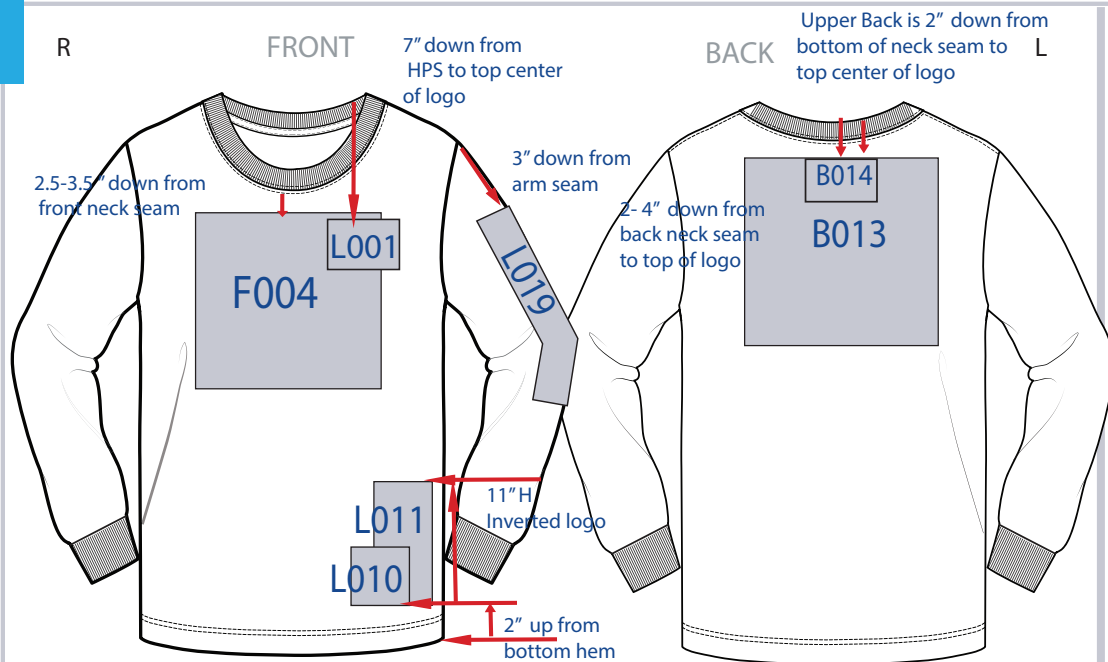

INFORMATION

*Available in:
Adult XS - 2X

* 4 oz. 100% ringspun cotton (exclusive of decoration)
* 1 x1 rib crew neckline and sleeve cuffs

SPECIAL INSTRUCTIONS

Screen print & embroidery
*no small details or distressed art for left chest or upper back center placements

L001 LEFT CHEST

ADULT : 3W x 3H MAX
PLACEMENT : 7" down from HPS to top of logo

F004 FRONT CENTER

ADULT : 12W x 12H MAX
PLACEMENT : 1.5" down from center neck seam to top of logo

B014 UPPER BACK CENTER

ADULT : 3W x 3H MAX
PLACEMENT : 1" down from the neck seam to top center of logo centered

B013 LOWER BACK

ADULT : 12W x 12H MAX
PLACEMENT : 1" down from the shoulder seam to top center of logo centered

L010 SHIRT HEM

ADULT : 4W x 4H MAX
PLACEMENT : 2" up from bottom hem to bottom of logo

L011 INVERTED HEM

ADULT : 3W x 11H MAX
PLACEMENT : 2"- 4" down from bottom hem to bottom of logo

L019 FULL SLEEVE

ADULT : 3W x 12H MAX
PLACEMENT : 3" down from arm seam to top of logo

AVAILABLE PROCESSES:

S E

S

S E

S

S

S

S

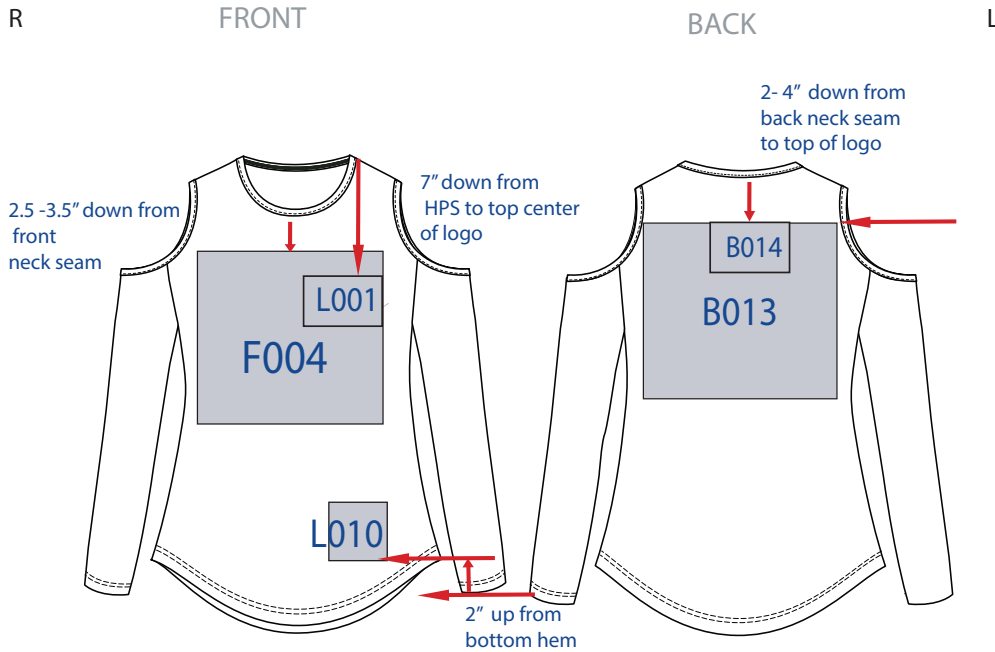

INFORMATION

- * Available in:
 - Adult XS - 2X
 - Plus 1XP-4XP
- * 3.5 oz. 60/40 Cotton/ Poly Jersey Slub
- * Bottom Hem Lightweight 100% Polyester Crepe
- * Short Sleeves Lightweight Printed Crepe Hem
- * Side Vents

SPECIAL INSTRUCTIONS

- * Screen print only
- * No small detail or distressed art on left chest

F004 FRONT CENTER

PLUS : 12W x 12H MAX
 ADULT : 9W x 9H MAX
 PLACEMENT : Centered 2.5" - 3.5" from neck seam to top of logo

L001 LEFT CHEST

ADULT : 3W x 3H MAX
 PLACEMENT : 7" down from High Point Shoulder point

B013 BACK CENTER

PLUS : 12W x 12H MAX
 ADULT : 10W x 10H MAX
 PLACEMENT : 2" - 4" down from neck seam to top of logo

B014 UPPER BACK CENTER

ADULT : 3W x 3H MAX
 PLACEMENT : 2" - 4" down from neck seam to top of logo

L010 SHIRT HEM

ADULT : 4W x 4H MAX
 PLACEMENT : 2" up from bottom hem to bottom of logo

AVAILABLE PROCESSES:



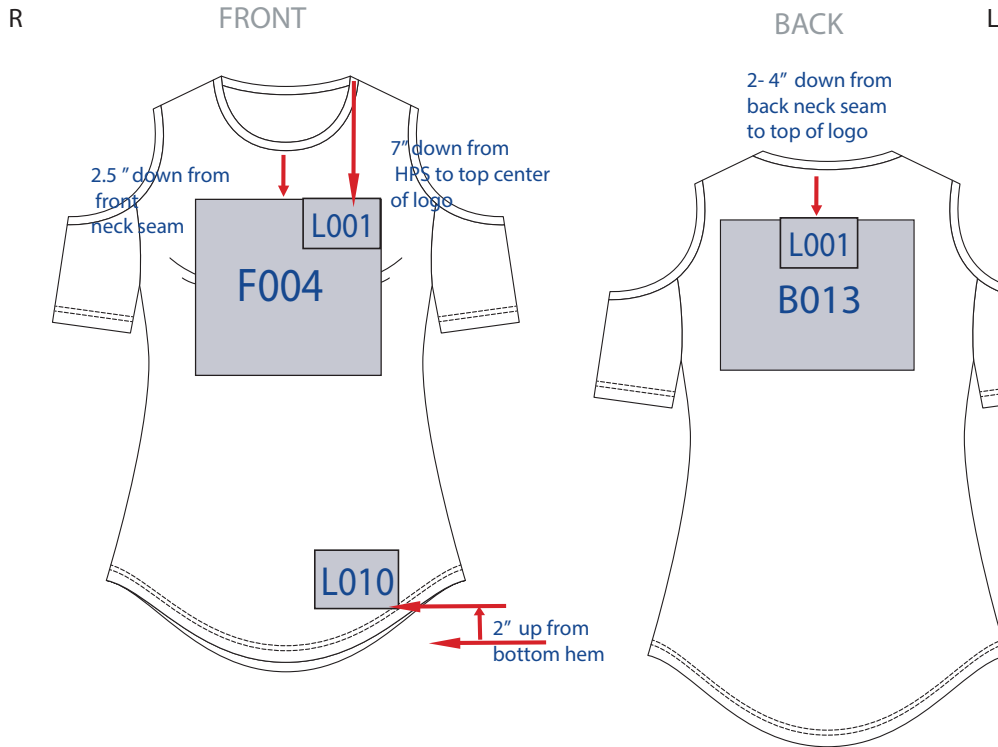

INFORMATION

- *Available in:
 - Adult XS - 2X
 - Youth YS - YL
- * 4.3 oz. 80/20 Poly/Cotton sueded jersey
- * Cold shoulder detailing
- * Contoured waistline for feminine fit
- * Shirt tail hem

SPECIAL INSTRUCTIONS

- * Screen print only
- * No small detail or distressed art on left chest

F004 FRONT CENTER

ADULT : 9W x 9H MAX
 PLACEMENT : Centered 2.5" - 3.5" from neck seam to top of logo

YOUTH: 7W x 7H MAX
 PLACEMENT : Centered 1.5" - 2.5" from neck seam to top of logo

L001 LEFT CHEST

ADULT : 3W x 3H MAX
 PLACEMENT : 7" down from High Point Shoulder point

YOUTH: 2W x 2H MAX
 PLACEMENT : 6" down from High Point Shoulder point

L010 SHIRT HEM

ADULT : 4W x 4H MAX
 PLACEMENT : 2" up from bottom hem to bottom of logo

YOUTH: 3W x 3H MAX
 PLACEMENT : 2" up from bottom hem to bottom of logo

B013 BACK CENTER

ADULT : 10W x 10H MAX
 PLACEMENT : 2"-4" down from neck seam to top of logo

YOUTH: 8W x 8H MAX
 PLACEMENT : 2"-4" down from neck seam to top of logo

B014 UPPER BACK CENTER

ADULT : 3W x 3H MAX
 PLACEMENT : 2"-4" down from neck seam to top of logo

YOUTH: 2W x 2H MAX
 PLACEMENT : 2"-4" down from neck seam to top of logo

AVAILABLE PROCESSES:



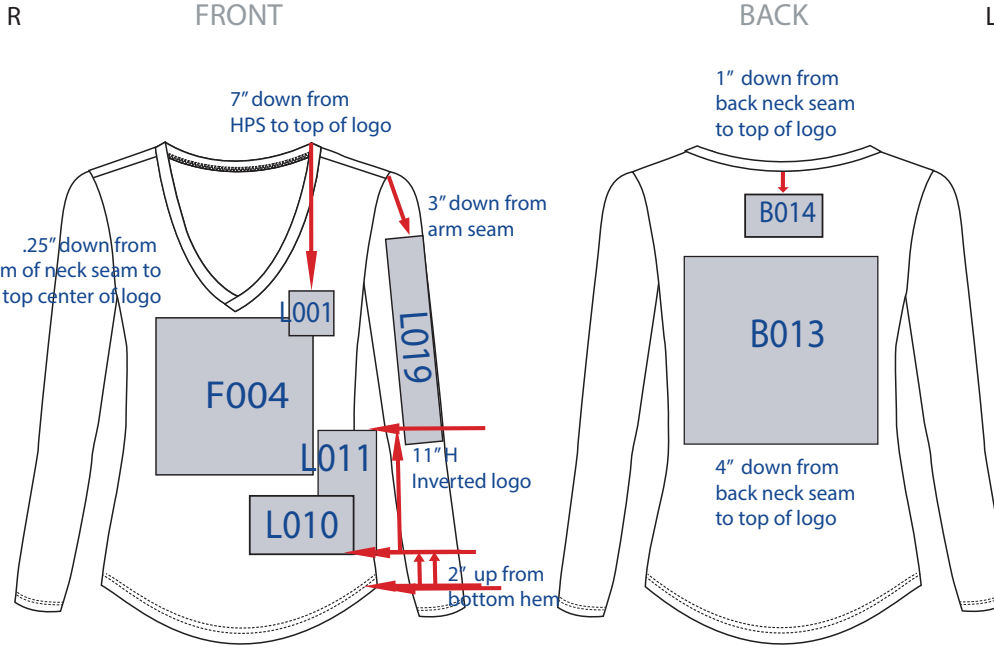

INFORMATION

*Available in:
Adult S - 2X

- *4 oz., 90/10 polyester/cotton snow heather jersey
- *Ladies-cut long sleeve V-neck tee
- *Self-fabric neck trim

SPECIAL INSTRUCTIONS

- * Screen print only
- * No small detail or distressed art on left chest
- ***PRODUCTION NOTE:** USE WHITE ONE STROKE UNDERBASE

L001 LEFT CHEST

ADULT: 3W x 3H MAX
PLACEMENT: 7" down from HPS to top of logo

F004 FRONT CENTER

ADULT: 9W x 9H MAX
PLACEMENT: 1.5" down from center neck seam to top of logo

B014 UPPER BACK CENTER

ADULT: 3W x 3H MAX
PLACEMENT: 1" down from the neck seam to top center of logo centered

B013 LOWER BACK

ADULT: 10W x 10H MAX
PLACEMENT: 1" down from the shoulder seam to top center of logo centered

L010 SHIRT HEM

ADULT: 4W x 4H MAX
PLACEMENT: 2" up from bottom hem to bottom of logo

L011 INVERTED HEM

ADULT: 3W x 11H MAX
PLACEMENT: 2"- 4" down from bottom hem to bottom of logo

L019 FULL SLEEVE

ADULT: 2W x 12H MAX
PLACEMENT: 3" down from arm seam to top of logo

AVAILABLE PROCESSES:



R

FRONT

BACK

L

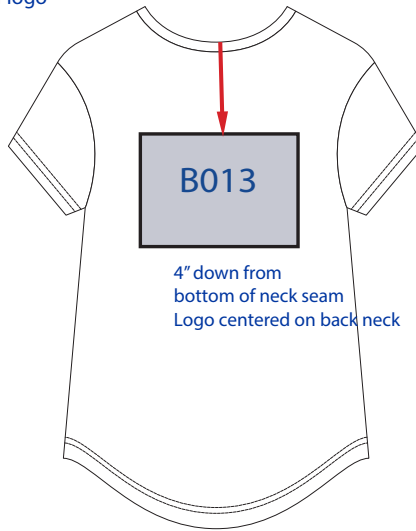
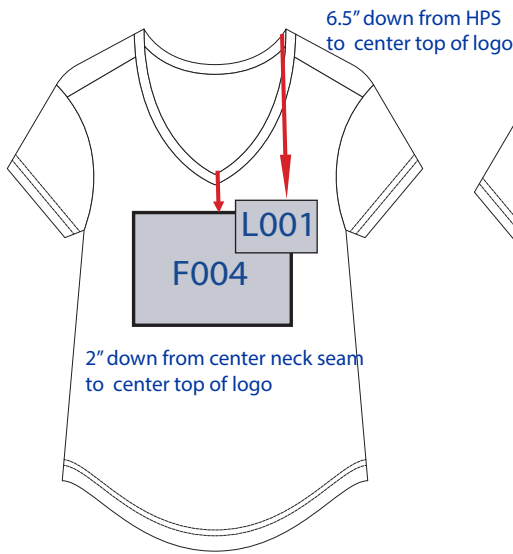

INFORMATION

- *Available in:
 - Adult XS - 3X
 - Youth YS - YL
- * 4.1 oz. 90/10 Poly/Cotton Snow Heather Jersey
- * Self-neck band with mitered neck
- * Forward-set shoulder seam
- Shirt tail hem

SPECIAL INSTRUCTIONS

- *Screen print only

L001 LEFT CHEST

ADULT : 3W x3H MAX
 PLACEMENT : 6.5" down from HPS to top of logo

YOUTH: 2W x 2H MAX
 PLACEMENT : 6" down from HPS to top of logo

F004 FRONT CENTER

ADULT : 9W x 9H MAX
 PLACEMENT : 2" down from center neck seam to top of logo

YOUTH: 7W x 7H MAX
 PLACEMENT : 2" down from center neck seam to top of logo

B013 BACK CENTER

ADULT : 9W x 9H MAX
 PLACEMENT : 4" down from center neck seam to top of logo

YOUTH: 7W x 7H MAX
 PLACEMENT: 3" down from bottom of the neck seam to top center of logo

AVAILABLE PROCESSES:



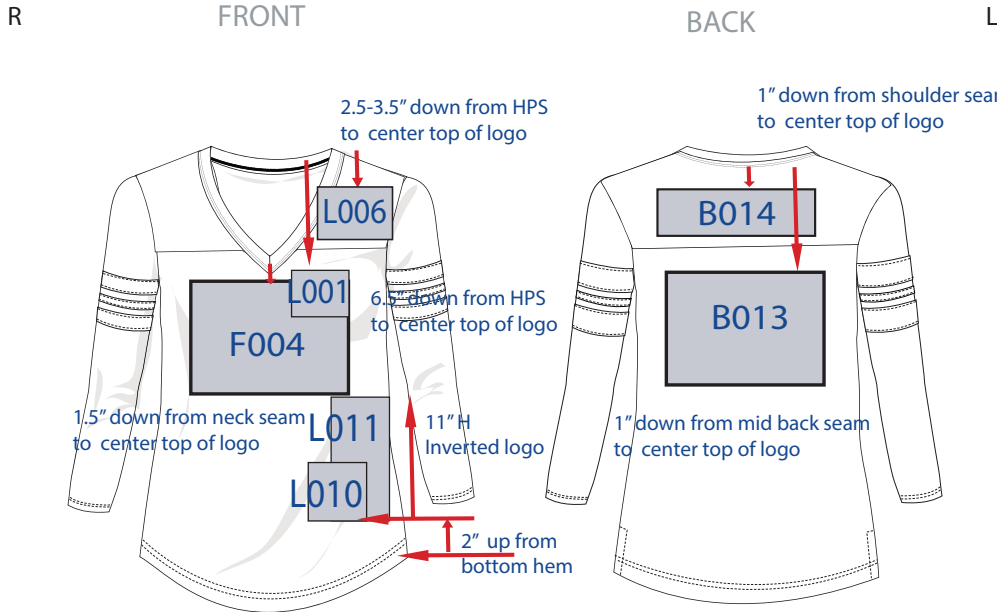

INFORMATION

- *Available in:
 Adult XS - 3X
 Youth YS - YL
- * 4.1 oz. 90/10 Polyester/Cotton Snow Heather Jersey (Exclusive of decoration)
- * Self-contrasting neck band
- * Mitered V-neck
- * Contrasting front and back yoke
- * White 100% cotton sleeve stripes
- * 3/4 sleeves
- * Shirtail hem

SPECIAL INSTRUCTIONS

Screen print only
 *no small details or distressed art for left chest or upper back center placements

L001 LEFT CHEST

ADULT : 3W x3H MAX
 PLACEMENT : 6" down from HPS to top of logo
 YOUTH: 2W x2H MAX
 PLACEMENT : 6" down from HPS to top of logo

F004 FRONT CENTER

ADULT : 12W x 12H MAX
 PLACEMENT : 1.5" down from center neck seam to top of logo
 YOUTH: 10W x 10H MAX
 PLACEMENT : 1.5" down from center neck seam to top of logo

B014 UPPER BACK CENTER

ADULT: 12W x 3H MAX
 PLACEMENT : 1" down from the neck seam to top center of logo centered
 YOUTH: 10W x 2H MAX
 PLACEMENT : 1" down from the neck seam to top center of logo centered

B013 LOWER BACK

ADULT: 12W x 12H MAX
 PLACEMENT : 1" down from the shoulder seam to top center of logo centered
 YOUTH: 10W x 10H MAX
 PLACEMENT : 1" down from the shoulder seam to top center of logo centered

L006 HIGH LEFT CHEST

ADULT : 2W x2H MAX
 PLACEMENT : 2.5" - 3.5" down from HPS to top of logo
 YOUTH: 1.5W x1.5H MAX
 PLACEMENT : 2.5" - 3.5" down from HPS to top of logo

L010 SHIRT HEM

ADULT : 4W x 4H MAX
 PLACEMENT : 2" up from bottom hem to bottom of logo
 YOUTH: 3W x 3H MAX
 PLACEMENT : 2" up from bottom hem to bottom of logo

L011 INVERTED HEM

ADULT : 3W x 11H MAX
 PLACEMENT : 2"- 4" down from bottom hem to bottom of logo
 YOUTH: 2W x 8H MAX
 PLACEMENT : 2"- 4" down from bottom hem to bottom of logo

AVAILABLE PROCESSES:



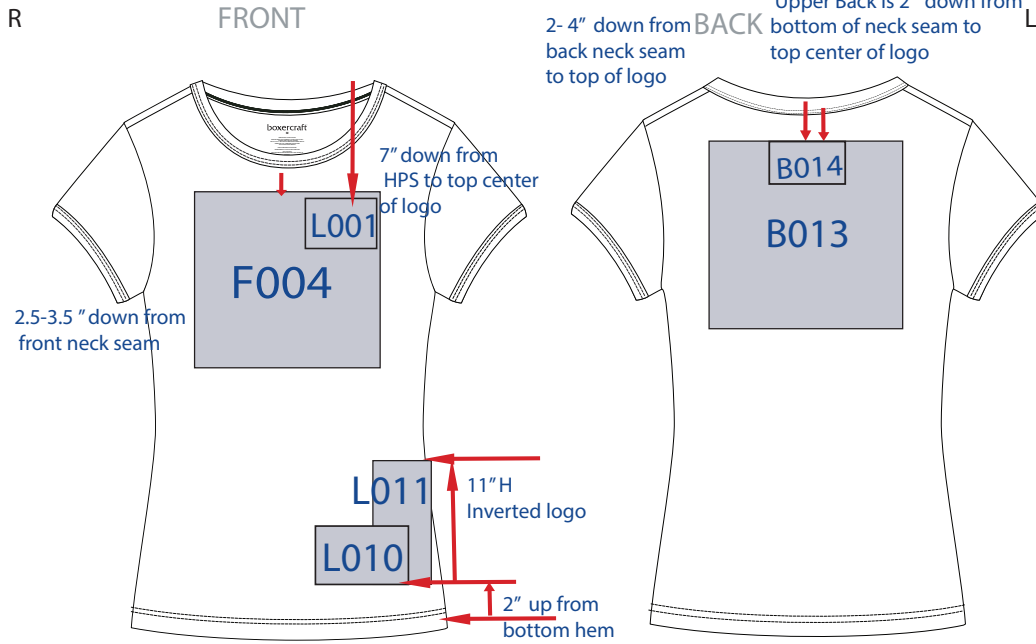

INFORMATION

- *Available in:
 - Adult XS - 3X
 - Youth YS-YL
- * 4 oz. 100% ringspun cotton jersey (exclusive of decoration)
- * Contrast binding at neck & sleeve

SPECIAL INSTRUCTIONS

- * Screen print only
- *No small detail or distressed art on left chest

F004 FRONT CENTER

ADULT : 9W x 9H MAX
 PLACEMENT : Centered 2.5" - 3.5" from neck seam to top of logo

YOUTH: 7W x 7H MAX
 PLACEMENT : Centered 1.5" - 2.5" from neck seam to top of logo

L001 LEFT CHEST

ADULT : 3W x 3H MAX
 PLACEMENT : 7" down from High Point Shoulder point

YOUTH: 2W x 2H MAX
 PLACEMENT : 6" down from High Point Shoulder point

L010 SHIRT HEM

ADULT : 4W x 4H MAX
 PLACEMENT : 2" up from bottom hem to bottom of logo

YOUTH: 3W x 3H MAX
 PLACEMENT : 2" up from bottom hem to bottom of logo

L011 INVERTED HEM

ADULT : 3W x 11H MAX
 PLACEMENT : 2" up from bottom hem to edge of logo (Inverted Art)

YOUTH: 2W x 8H MAX
 PLACEMENT : 2" up from bottom hem to edge of logo (inverted art)

B013 BACK CENTER

ADULT : 10W x 10H MAX
 PLACEMENT : 2"-4" down from neck seam to top of logo

YOUTH: 8W x 8H MAX
 PLACEMENT : 2"-4" down from neck seam to top of logo

B014 UPPER BACK CENTER

ADULT : 3W x 3H MAX
 PLACEMENT : 2"-4" down from neck seam to top of logo

YOUTH: 2W x 2H MAX

AVAILABLE PROCESSES:



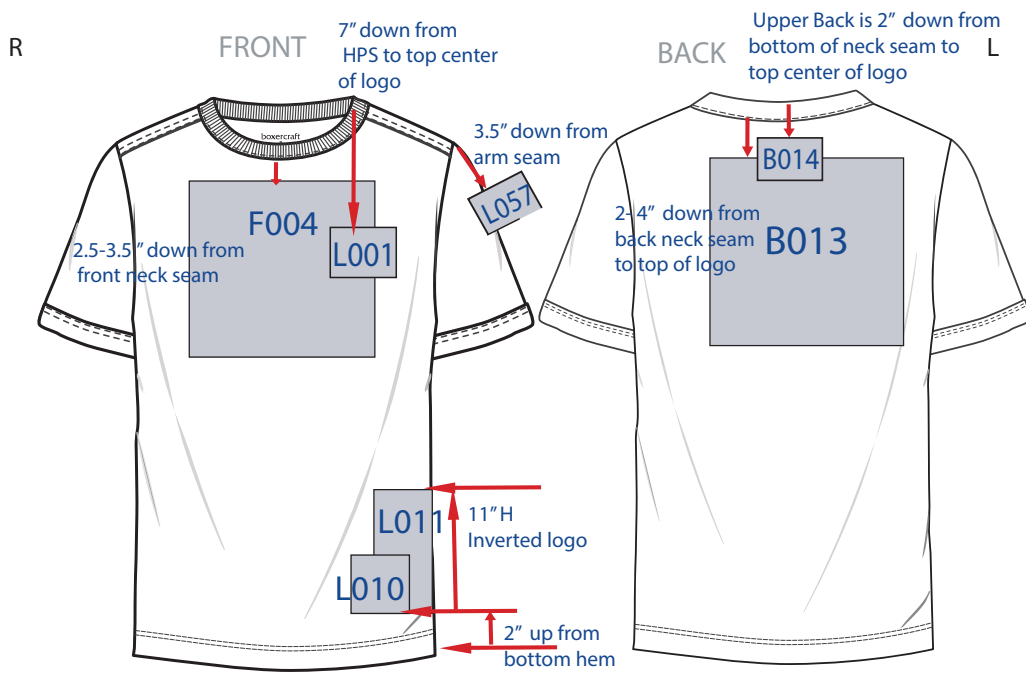

INFORMATION

- *Available in:
 - Adult XS - 3X
 - Youth YS-YL
- * 4 Oz. 100% ringspun cotton jersey (exclusive of decoration)
- * Contrast binding at neck & sleeve

SPECIAL INSTRUCTIONS

- * Screen print only
- * No small detail or distressed art on left chest

F004 FRONT CENTER

ADULT: 12W x 12H MAX
 PLACEMENT: Centered 2.5" - 3.5" from neck seam to top of logo

YOUTH: 10W x 10H MAX
 PLACEMENT: Centered 1.5" - 2.5" from neck seam to top of logo

L001 LEFT CHEST

ADULT: 3W x 3H MAX
 PLACEMENT: 7" down from High Point Shoulder point

YOUTH: 2W x 2H MAX
 PLACEMENT: 6" down from High Point Shoulder point

L010 SHIRT HEM

ADULT: 4W x 4H MAX
 PLACEMENT: 2" up from bottom hem to bottom of logo

YOUTH: 3W x 3H MAX
 PLACEMENT: 2" up from bottom hem to bottom of logo

L011 INVERTED HEM

ADULT: 3W x 11H MAX
 PLACEMENT: 2" up from bottom hem to edge of logo (Inverted Art)

YOUTH: 2W x 8H MAX
 PLACEMENT: 2" up from bottom hem to edge of logo (inverted art)

B013 BACK CENTER

ADULT: 14W x 12H MAX
 PLACEMENT: 2"-4" down from neck seam to top of logo

YOUTH: 12W x 10H MAX
 PLACEMENT: 2"-4" down from neck seam to top of logo

B014 UPPER BACK CENTER

ADULT: 3W x 3H MAX
 PLACEMENT: 2"-4" down from neck seam to top of logo

YOUTH: 2W x 2H MAX
 PLACEMENT: 2" down from bottom center neck seam centered on back neck

L057 SHOULDER SLEEVE

ADULT: 3W x 3H MAX
 PLACEMENT: 3.5" down from arm seam

YOUTH: 2W x 2H MAX
 PLACEMENT: 2.5" down from arm seam

AVAILABLE PROCESSES:



R

FRONT

BACK

L

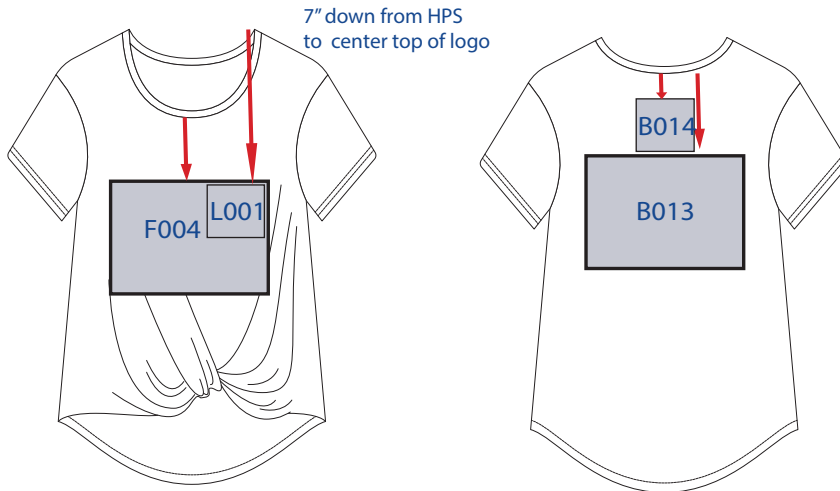

INFORMATION

- *Available in:
 - Adult XS - 3X
 - Youth YS - YL
- * 5.2 oz. 65/35 Polyester/Rayon Jersey (Exclusive of decoration)
- * Back neck tape
- * Self-neck band
- * Twist detail at front hem

SPECIAL INSTRUCTIONS

- * Screen print only

L001 LEFT CHEST

ADULT : 3W x 3H MAX
 PLACEMENT : 6.5" down from HPS to top of logo

YOUTH: 2W x 2H MAX
 PLACEMENT : 6" down from HPS to top of logo

F004 FRONT CENTER

ADULT : 9W x 9H MAX
 PLACEMENT : 2" down from center neck seam to top of logo

YOUTH: 7W x 7H MAX
 PLACEMENT : 2" down from center neck seam to top of logo

B013 BACK CENTER

ADULT : 9W x 9H MAX
 PLACEMENT : 4" down from center neck seam to top of logo

YOUTH: 7W x 7H MAX
 PLACEMENT : 4" down from center neck seam to top of logo

B014 UPPER BACK CENTER

ADULT : 1.5W x 1.5H MAX
 PLACEMENT : 1.5" down from back neck seam & centered

YOUTH: 1W x 1H MAX
 PLACEMENT: 1.5" down from back neck seam & centered

AVAILABLE PROCESSES:



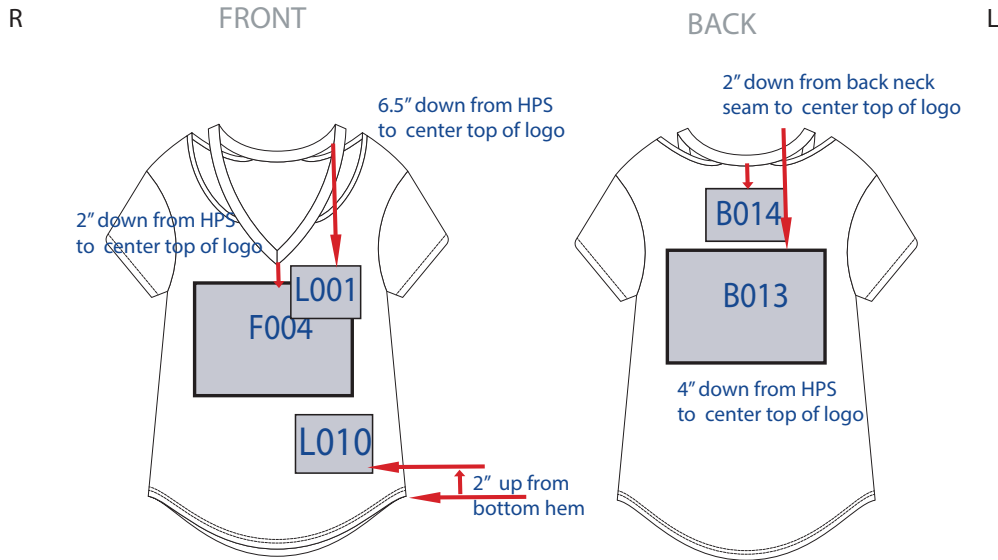

INFORMATION

- *Available in:
Adult XS - 3X
- * 5.2 oz. 65/35 Polyester/Rayon Jersey (Exclusive of decoration)
- * Self-neck binding
- * Open neck detail at neck
- * Mitered V-Neck
- * Shirt tail hem

SPECIAL INSTRUCTIONS

- * Screen print only
- * No small detail or distressed art on left chest

L001 LEFT CHEST

ADULT : 3W x 3H MAX
PLACEMENT : 6.5" down from HPS to top of logo

F004 FRONT CENTER

ADULT : 9W x 9H MAX
PLACEMENT : 2.5"-3.5" down from center neck seam to top of logo

B013 BACK CENTER

ADULT : 10W x 10H MAX
PLACEMENT : 4" down from center neck seam to top of logo

B014 UPPER BACK CENTER

ADULT : 3W x 3H MAX
PLACEMENT : 4" down from center neck seam to top of logo

L010 SHIRT HEM

ADULT : 4W x 4H MAX
PLACEMENT : 2" up from bottom hem to bottom of logo

AVAILABLE PROCESSES:



R

FRONT

BACK

L

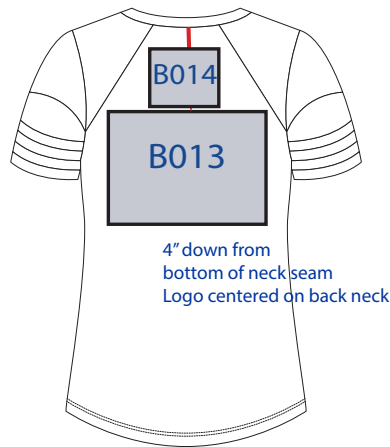
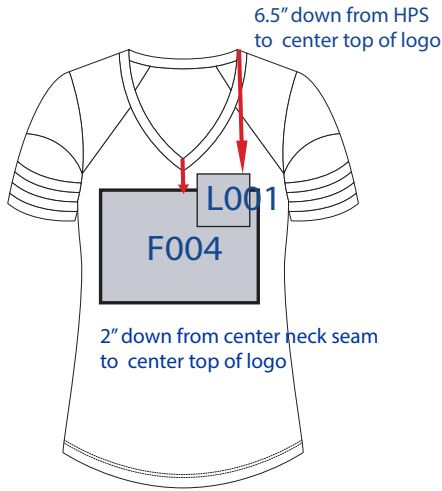

INFORMATION

- *Available in:
 - Adult XS - 3X
 - Youth YS - YL
- * 5.2 oz. 65/35 Polyester/Rayon Jersey (Exclusive of decoration)
- * Mitered V-Neck
- * Contrasting shoulder/neck panels
- * Contrasting sleeve stripes

SPECIAL INSTRUCTIONS

- * Screen print only
- * No small detail or distressed art on left chest

L001 LEFT CHEST

ADULT : 3W x 3H MAX
 PLACEMENT : 6.5" down from HPS to top of logo

YOUTH: 2W x 2H MAX
 PLACEMENT : 6" down from HPS to top of logo

F004 FRONT CENTER

ADULT : 9W x 9H MAX
 PLACEMENT : 2.5"-3.5" down from center neck seam to top of logo

YOUTH: 7W x 7H MAX
 PLACEMENT : 2.5"-3.5" down from center neck seam to top of logo

B013 BACK CENTER

ADULT : 10W x 10H MAX
 PLACEMENT : 4" down from center neck seam to top of logo

YOUTH: 8W x 8H MAX
 PLACEMENT : 3" down from center neck seam to top of logo

B014 UPPER BACK CENTER

ADULT : 3W x 3H MAX
 PLACEMENT : 4" down from center neck seam to top of logo

YOUTH: 2W x 2H MAX
 PLACEMENT : 3" down from center neck seam to top of logo

AVAILABLE PROCESSES:



R

FRONT

BACK

L

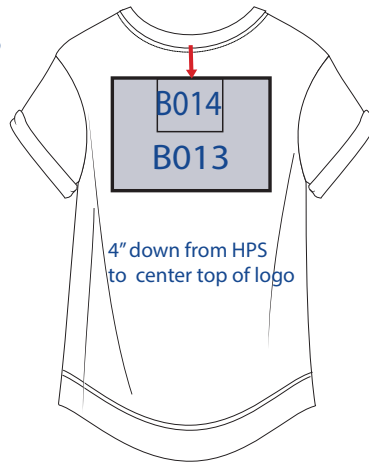
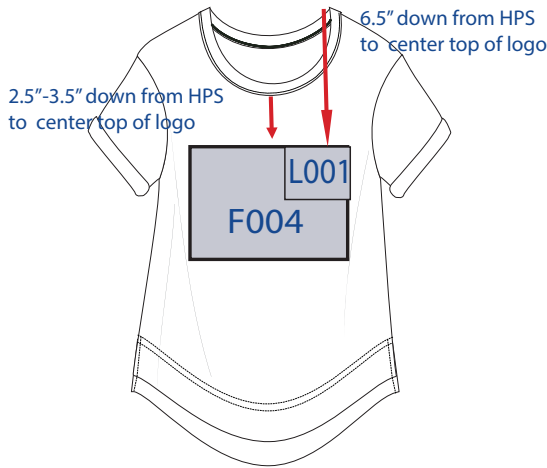

INFORMATION

- *Available in:
 - Adult XS - 3X
 - Youth YS - YL
- * 5.3 oz. 100% Cotton Garment -Dyed Jersey (Exclusive of decoration)
- * Self-neck band
- * Rolled sleeve cuff
- * Side vent
- * Slight high low hem

SPECIAL INSTRUCTIONS

- * Screen print only
- * No small detail or distressed art on left chest

L001 LEFT CHEST

ADULT : 3W x3H MAX
 PLACEMENT : 6.5" down from HPS to top of logo

YOUTH: 2W x 2H MAX
 PLACEMENT : 6" down from HPS to top of logo

F004 FRONT CENTER

ADULT : 9W x 9H MAX
 PLACEMENT : 2.5"-3.5" down from center neck seam to top of logo

YOUTH: 7W x 7H MAX
 PLACEMENT : 2.5"-3.5" down from center neck seam to top of logo

B013 BACK CENTER

ADULT : 10W x 10H MAX
 PLACEMENT : 4" down from center neck seam to top of logo

YOUTH: 8W x 8H MAX
 PLACEMENT : 3" down from center neck seam to top of logo

B014 UPPER BACK CENTER

ADULT : 3W x 3H MAX
 PLACEMENT : 4" down from center neck seam to top of logo

YOUTH: 2W x 2H MAX
 PLACEMENT : 3" down from center neck seam to top of logo

AVAILABLE PROCESSES:



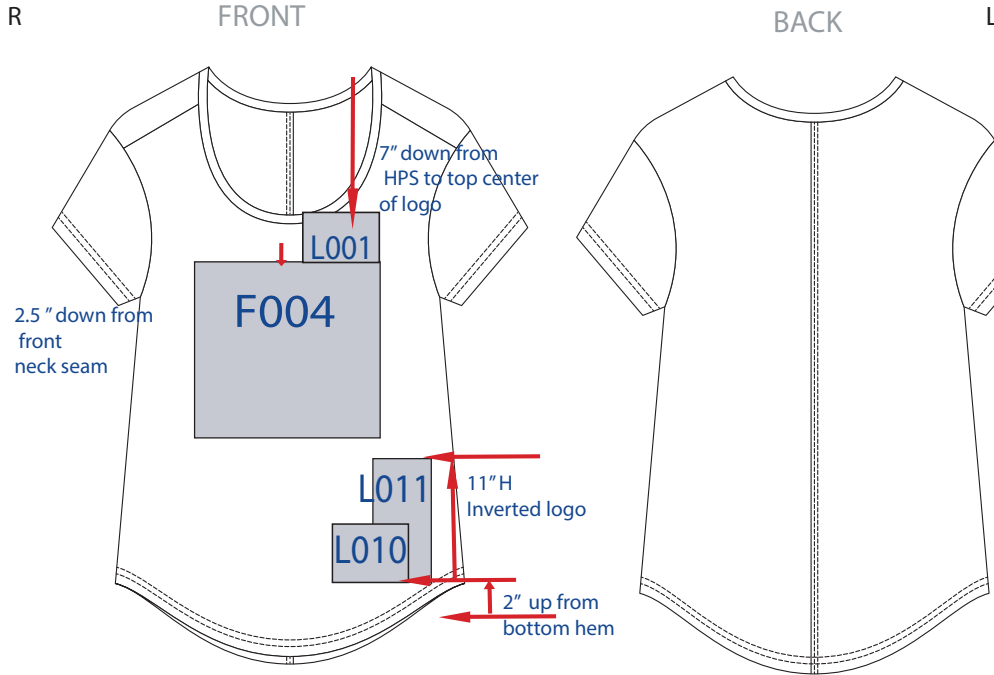

INFORMATION

- * Available in:
Adult XS - 3X
- * 4.3 oz. 80/20 Poly/Cotton
sueded jersey
- * Scoop neck
- * Relaxed fit
- * Shirt tail hem

SPECIAL INSTRUCTIONS

- * Screen print only
- * No small detail or distressed
art on left chest

F004 FRONT CENTER

ADULT : 10W x 10H MAX
PLACEMENT : Centered 2.5" - 3.5" from neck seam to top of logo

L001 LEFT CHEST

ADULT : 3W x 3H MAX
PLACEMENT : 7" down from High Point Shoulder point

L010 SHIRT HEM

ADULT : 4W x 4H MAX
PLACEMENT : 2" up from bottom hem to bottom of logo

L011 INVERTED HEM

ADULT : 3W x 11H MAX
PLACEMENT : 2" up from bottom hem to edge of logo (Inverted Art)

AVAILABLE PROCESSES:

S

S

S

S

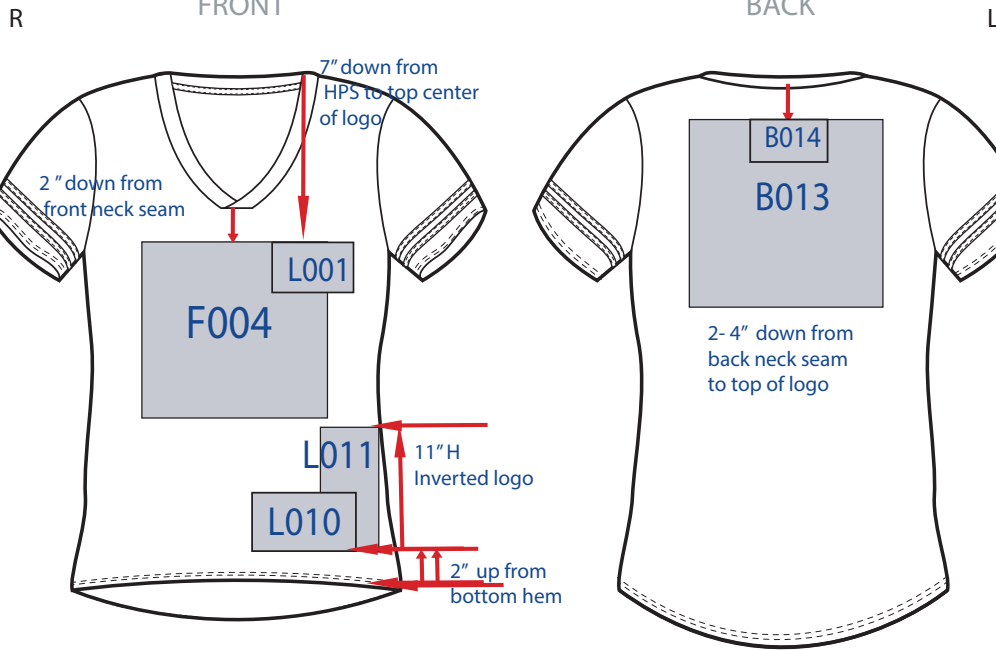

INFORMATION

- * Available in:
 - Adult XS - 2X
 - Youth YS - YL
 - Plus 1XP-4XP
- * Women's Fit
- * 3.5 oz 60/40 Cotton Poly Slub Jersey
- * High/ Low Hem
- * V Neck

SPECIAL INSTRUCTIONS

- * Screen print only
- * No small detail or distressed art on left chest

F004 FRONT CENTER

ADULT : 9W x 9H MAX
 PLACEMENT : Centered 2" down from neck seam to top of logo
 PLUS: 12W x 12H

YOUTH: 7W x 7H MAX
 PLACEMENT : Centered 2" down from neck seam to top of logo

L001 LEFT CHEST

ADULT : 3W x 3H MAX
 PLACEMENT : 7" down from High Point Shoulder point

YOUTH: 2W x 2H MAX
 PLACEMENT : 6" down from High Point Shoulder point

L010 SHIRT HEM

ADULT : 4W x 4H MAX
 PLACEMENT : 2" up from bottom hem to bottom of logo

YOUTH: 3W x 3H MAX
 PLACEMENT : 2" up from bottom hem to bottom of logo

B013 BACK CENTER

ADULT : 10W x 10H MAX
 PLACEMENT : 2"-4" down from neck seam to top of logo
 PLUS: 12W x 12H

YOUTH: 8W x 8H MAX
 PLACEMENT : 2"-4" down from neck seam to top of logo

L011 INVERTED HEM

ADULT : 3W x 11H MAX
 PLACEMENT : 2"-4" down from bottom hem to bottom of logo

YOUTH: 2W x 8H MAX
 PLACEMENT : 2"-4" down from bottom hem to bottom of logo

B014 UPPER BACK CENTER

ADULT : 3W x 3H MAX
 PLACEMENT : 2"-4" down from neck seam to top of logo

YOUTH: 2W x 2H MAX
 PLACEMENT : 2"-4" down from neck seam to top of logo

AVAILABLE PROCESSES:



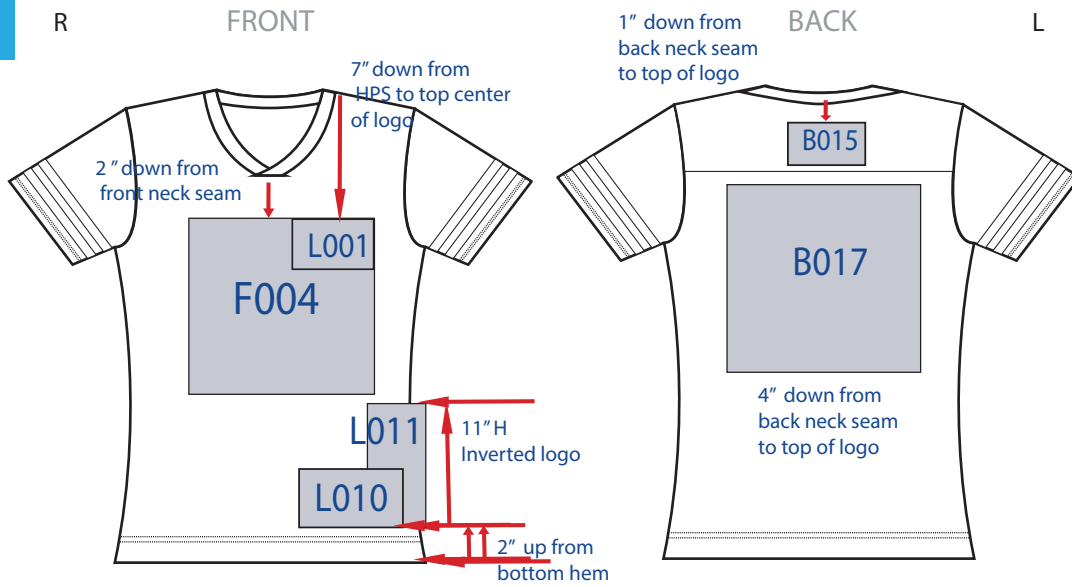

INFORMATION

- * Available in:
 - Adult XS - 2X
 - Youth YS - YL
- * Women's Fit
- * 4 oz. 100% Ringspun Cotton
- * Screen Print
- * Shoulder Yoke Always White
- * Bottom Half of Shirt, Neckline, and Sleeve Stripes Always Match

SPECIAL INSTRUCTIONS

- * Screen print only
- * No small detail or distressed art on left chest

F004 FRONT CENTER

ADULT : 9W x 9H MAX
 PLACEMENT : Centered 2" down from neck seam to top of logo

YOUTH: 7W x 7H MAX
 PLACEMENT : Centered 1.5" down from neck seam to top of logo

L001 LEFT CHEST

ADULT : 3W x 3H MAX
 PLACEMENT : 7" down from High Point Shoulder point

YOUTH: 2W x 2H MAX
 PLACEMENT : 6" down from High Point Shoulder point

L010 SHIRT HEM

ADULT : 4W x 4H MAX
 PLACEMENT : 2" up from bottom hem to bottom of logo

YOUTH: 3W x 3H MAX
 PLACEMENT : 2" up from bottom hem to bottom of logo

L011 INVERTED HEM

ADULT : 3W x 11H MAX
 PLACEMENT : 2" up from bottom hem to bottom of logo

YOUTH: 2W x 8H MAX
 PLACEMENT : 2" up from bottom hem to bottom of logo

B015 UPPER BACK

ADULT : 9W x 2.5H MAX
 PLACEMENT : 1" down from neck seam to top of logo

YOUTH: 7W x 1.5H MAX
 PLACEMENT : 1" down from neck seam to top of logo

B017 LOWER BACK

ADULT : 10W x 10H MAX
 PLACEMENT : 4" down from neck seam to top of logo

YOUTH: 8W x 8H MAX
 PLACEMENT : 3" down from neck seam to top of logo

AVAILABLE PROCESSES:



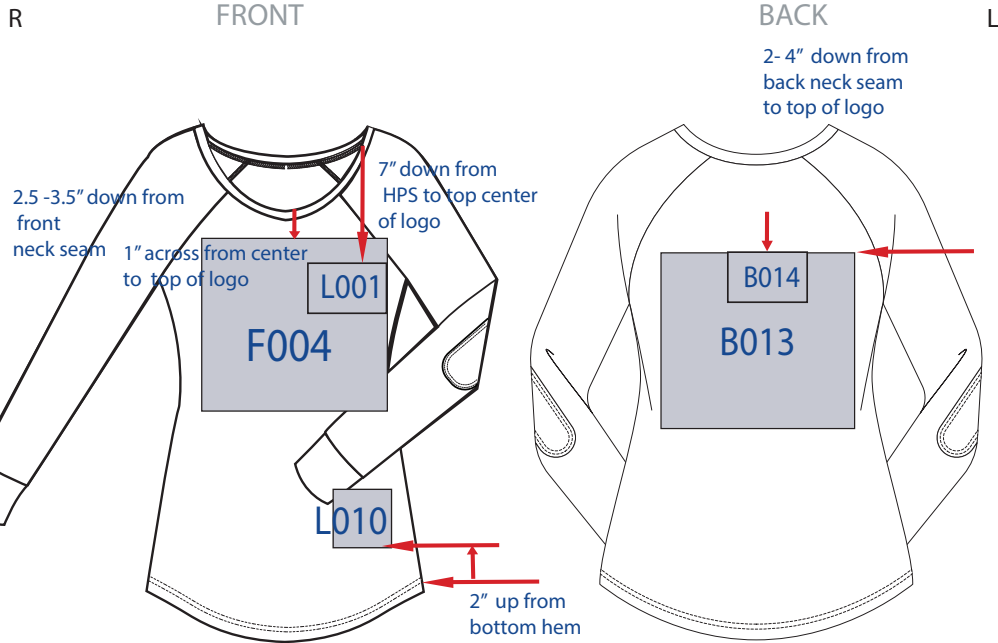

INFORMATION

- * Available in:
 - Adult XS - 2X
 - Plus 1XP-4XP
 - Youth YS- YL
- * Ladies Fit
- * 3.5oz 60/40 Cotton/ Poly Slub Jersey
- * Raglan Sleeves
- * Self Fabric Elbow Patches (they are not printable)
- * All Sleeves are always Granite Color

SPECIAL INSTRUCTIONS

- * Screen print only
- * No small detail or distressed art on left chest
- * Must underbase

F004 FRONT CENTER	<p>PLUS : 12W x 12H MAX</p> <p>ADULT : 9W x 9H MAX</p> <p>PLACEMENT : Centered 2" from neck seam to top of logo. 2" down from center bottom seam to top of logo, 1" across from center point</p> <p>YOUTH : 7W x 7H MAX</p> <p>PLACEMENT : Centered 1.5" from neck seam to top of logo. 2" down from center bottom seam to top of logo, 1" across from center point</p>
L001 LEFT CHEST	<p>ADULT : 3W x 3H MAX</p> <p>PLACEMENT : 6" down from High Point Shoulder point, 2" down from center bottom seam to top of logo</p> <p>YOUTH : 2W x 2H MAX</p> <p>PLACEMENT : 5" down from High Point Shoulder point, 2" down from center bottom seam to top of logo</p>
L010 SHIRT HEM	<p>ADULT : 4W x 4H MAX</p> <p>PLACEMENT : 2" up from bottom hem to bottom of logo</p> <p>YOUTH : 3W x 3H MAX</p> <p>PLACEMENT : 2" up from bottom hem to bottom of logo</p>
B013 BACK CENTER	<p>PLUS : 12W x 12H MAX</p> <p>ADULT : 10W x 10H MAX</p> <p>PLACEMENT : 2"- 4" down from neck seam to top of logo</p> <p>YOUTH : 8W x 8H MAX</p> <p>PLACEMENT : 2"- 4" down from neck seam to top of logo</p>
L011 INVERTED HEM	<p>ADULT : 3W x 11H MAX</p> <p>PLACEMENT : 2"- 4" down from bottom hem to bottom of logo</p> <p>YOUTH : 2W x 8H MAX</p> <p>PLACEMENT : 2"- 4" down from bottom hem to bottom of logo</p>
B014 UPPER BACK CENTER	<p>ADULT : 3W x 3H MAX</p> <p>PLACEMENT : 2"- 4" down from neck seam to top of logo</p> <p>YOUTH : 2W x 2H MAX</p> <p>PLACEMENT : 2"- 4" down from neck seam to top of logo</p>

AVAILABLE PROCESSES:

S

S

S

S

S

S

R

FRONT

7" down from HPS to top center of logo

2.5-3.5" down from front neck seam

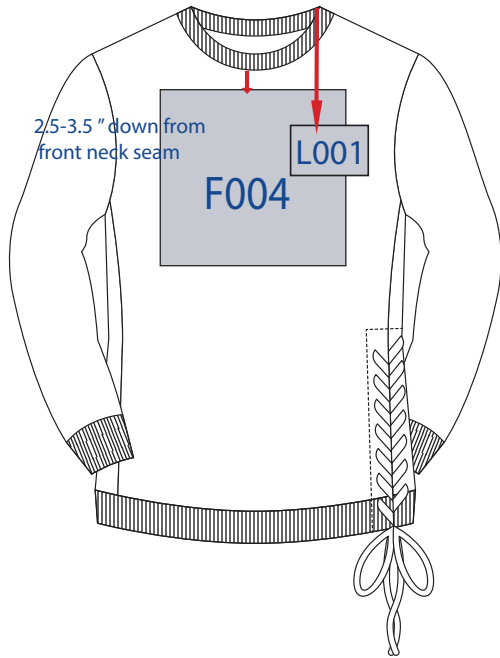

BACK

Upper Back is 2" down from bottom of neck seam to top center of logo

2-4" down from back neck seam to top of logo

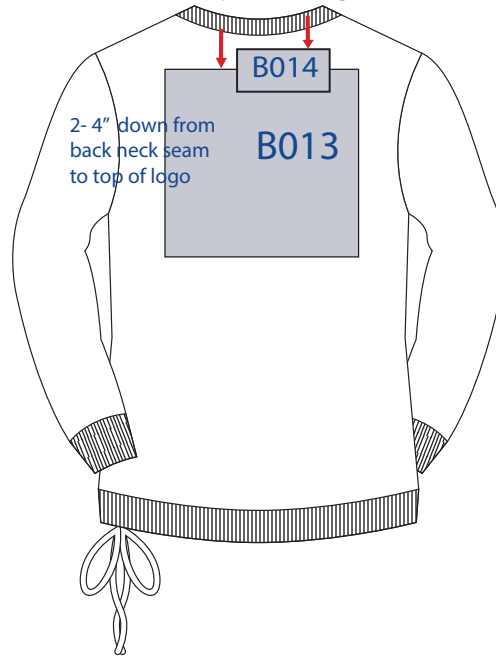

INFORMATION

*Available in:
Adult XS - 3X

- * 6.5 oz. 60/40 Cotton/ Polyester Enzyme & Stone washed fleece (exclusive of decoration)
- * Rib neckband/sleeve cuffs/ bottom band
- * Forwarded side seam
- * Lace up detail on left side

SPECIAL INSTRUCTIONS

Screen print & embroidery
*NO SMALL DETAILS OR DISTRESSED ART on left chest

F004 FRONT CENTER

ADULT : 10W x 10H MAX
PLACEMENT : Centered 2.5" - 3.5" from neck seam to top of logo

L001 LEFT CHEST

ADULT : 3W x 3H MAX
PLACEMENT : 7" down from High Point Shoulder point

B013 BACK CENTER

ADULT : 12W x 12H MAX
PLACEMENT : 2"-4" down from neck seam to top of logo

B014 UPPER BACK CENTER

ADULT : 3W x 3H MAX
PLACEMENT : 2"-4" down from neck seam to top of logo

AVAILABLE PROCESSES:



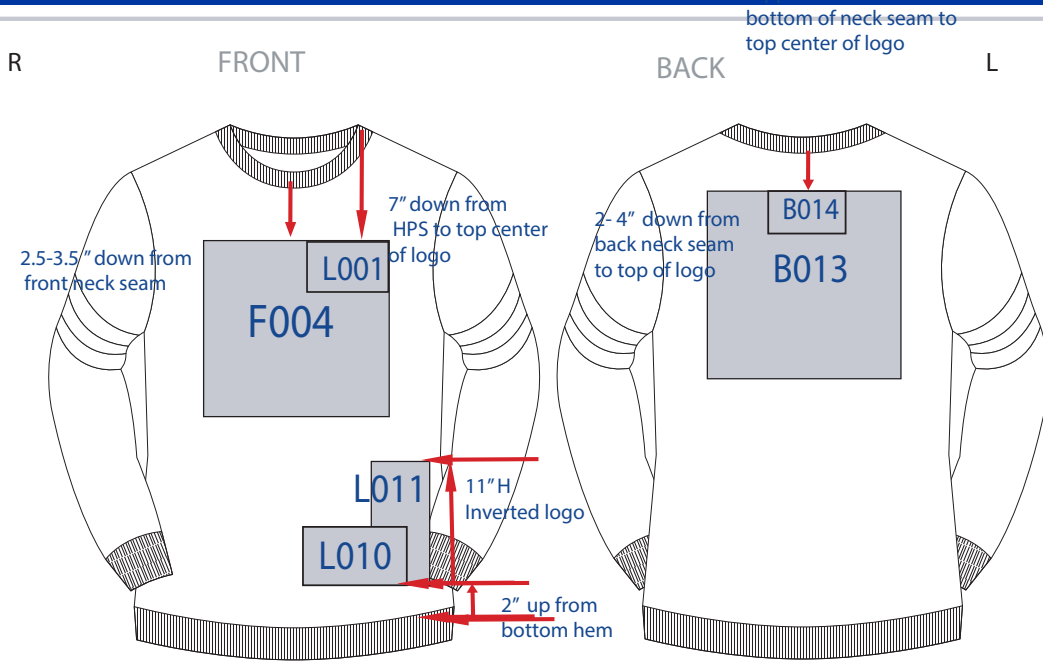

INFORMATION

- *Available in:
 - Adult XS - 3X
 - Youth YS-YL
- * 6.5 oz. 60/40 Cotton/ Polyester Enzyme & Stone washed fleece (exclusive of decoration)
- * Rib neck band/sleeve cuffs/ bottom band
- * Self sleeve stripes

SPECIAL INSTRUCTIONS

- * Screen print & Embroidery
- * No small detail or distressed art on left chest

F004 FRONT CENTER

ADULT : 12W x 12H MAX
 PLACEMENT : Centered 2.5" - 3.5" from neck seam to top of logo

YOUTH: 10W x 10H MAX
 PLACEMENT : Centered 1.5" - 2.5" from neck seam to top of logo

L001 LEFT CHEST

ADULT : 3W x 3H MAX
 PLACEMENT : 7" down from High Point Shoulder point

YOUTH: 2W x 2H MAX
 PLACEMENT : 6" down from High Point Shoulder point

L010 SHIRT HEM

ADULT : 4W x 4H MAX
 PLACEMENT : 2" up from bottom hem to bottom of logo

YOUTH: 3W x 3H MAX
 PLACEMENT : 2" up from bottom hem to bottom of logo

B013 BACK CENTER

ADULT : 14W x 12H MAX
 PLACEMENT : 2"-4" down from neck seam to top of logo

YOUTH: 12W x 10H MAX
 PLACEMENT : 2"-4" down from neck seam to top of logo

L011 INVERTED HEM

ADULT : 3W x 11H MAX
 PLACEMENT : 2"-4" down from bottom hem to bottom of logo

YOUTH: 2W x 8H MAX
 PLACEMENT : 2"-4" down from bottom hem to bottom of logo

B014 UPPER BACK CENTER

ADULT : 3W x 3H MAX
 PLACEMENT : 2"-4" down from neck seam to top of logo

YOUTH: 2W x 2H MAX

AVAILABLE PROCESSES:



R FRONT BACK L

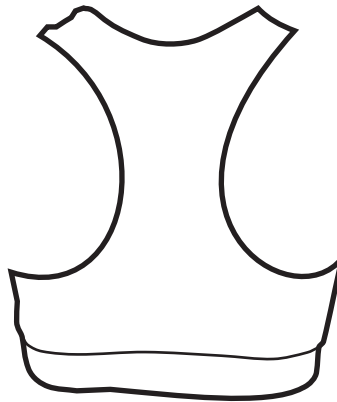
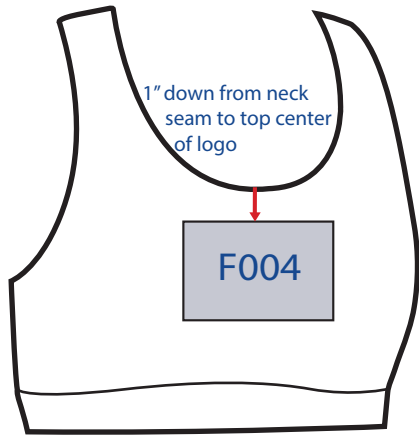

INFORMATION

- * Available in:
 - Adult XS - XL
 - Youth YS - YL
- * Women's Fit
- * 6.5 oz 90/10 Cotton Spandex
- * No Bra Pads

SPECIAL INSTRUCTIONS

- Screen print only
- * PRINT OPTION:
MANUAL PRESS ONLY

F004 FRONT CENTER CHEST

ADULT : 7W x 3H MAX
 PLACEMENT : 1" down from center
 YOUTH: 6W x 2H MAX
 PLACEMENT : 1" down from center

AVAILABLE PROCESSES:



R

FRONT

BACK

L

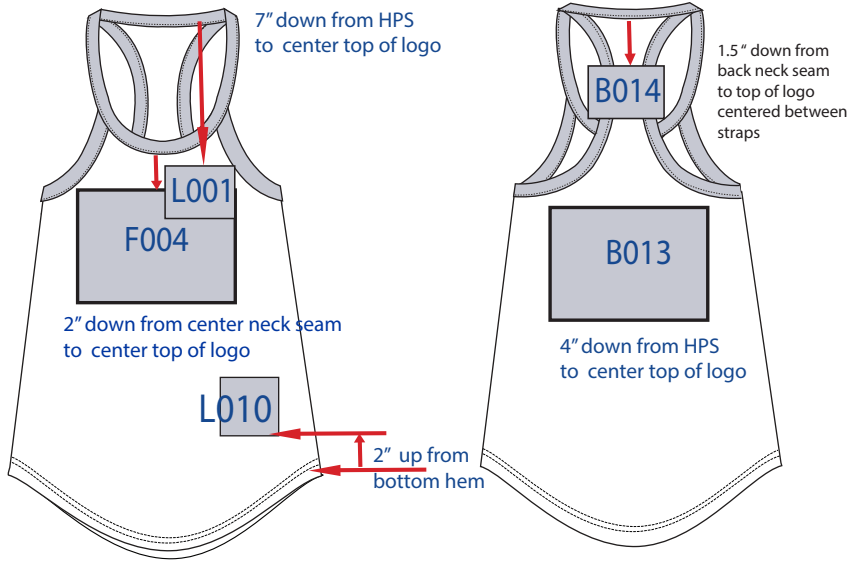

INFORMATION

- * Available in:
 - Adult XS - 3X
 - Youth YS - YL
- * 4.0 oz. 100% Cotton Jersey (exclusive of decoration)
- * 100% Cotton neck/armhole bindings
- * Racerback detail on back
- * Shirt tail hem

SPECIAL INSTRUCTIONS

- * Screen print only
- * no small details or distressed art for left chest or upper back center placements
- * Heavy Prints not recommended

L001 LEFT CHEST

ADULT : 3W x 3H MAX
 PLACEMENT : 6.5" down from HPS to top of logo

YOUTH: 2W x 2H MAX
 PLACEMENT : 6" down from HPS to top of logo

F004 FRONT CENTER

ADULT : 9W x 9H MAX
 PLACEMENT : 2" down from center neck seam to top of logo

YOUTH: 7W x 7H MAX
 PLACEMENT : 2" down from center neck seam to top of logo

B014 UPPER BACK CENTER

ADULT : 1.5W x 5H MAX
 PLACEMENT : 1.5" down from back neck seam to top of logo centered between straps

YOUTH: 1W x 4H MAX
 PLACEMENT: 1.5" down from back neck seam to top of logo centered between straps

B013 BACK CENTER

ADULT : 10W x 10H MAX
 PLACEMENT : 4" down from center neck seam to top of logo

YOUTH: 8W x 8H MAX
 PLACEMENT : 3" down from center neck seam to top of logo

L010 SHIRT HEM

ADULT : 4W x 4H MAX
 PLACEMENT : 2" up from bottom hem to bottom of logo

YOUTH: 3W x 3H MAX
 PLACEMENT : 2" up from bottom hem to bottom of logo

AVAILABLE PROCESSES:

- S
- S
- S
- S
- S

R

FRONT

BACK

L

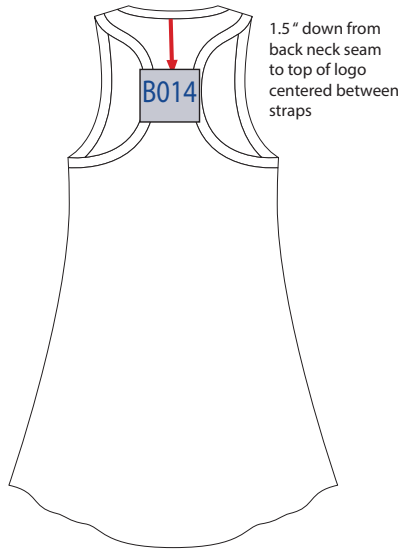
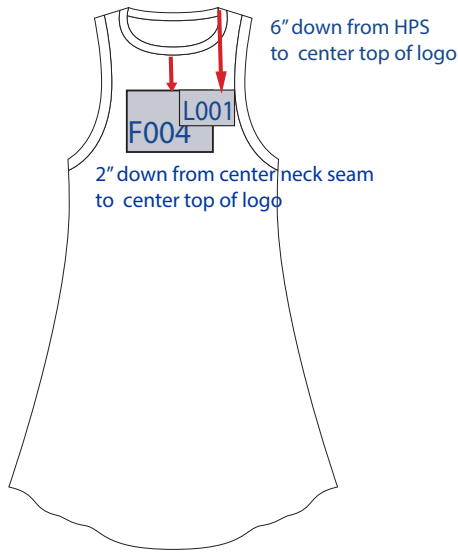

INFORMATION

- *Available in:
 - Adult XS - 2X
 - Youth YS - YL
- * 4.3 oz. 50/38/12 Polyester/Cotton /Rayon Heather Tri-blend Jersey (Exclusive of decoration)
- * 100% Cotton rib neck/armhole binding
- *Racerback detail on back
- Fit and flair body

SPECIAL INSTRUCTIONS

- * Screen print only
- *no small details or distressed art for left chest or upper back center placements
- * Heavy Prints not recommended

L001 LEFT CHEST

ADULT : 3W x3H MAX
 PLACEMENT : 6.5" down from HPS to top of logo

YOUTH: 2W x 2H MAX
 PLACEMENT : 6" down from HPS to top of logo

F004 FRONT CENTER

ADULT : 9W x 9H MAX
 PLACEMENT : 2" down from center neck seam to top of logo

YOUTH: 7W x 7H MAX
 PLACEMENT : 2" down from center neck seam to top of logo

B014 UPPER BACK CENTER

ADULT : 1 W x 5 H MAX
 PLACEMENT : 1.5" down from back neck seam to top of logo centered between straps

YOUTH: .5 W x 4 H MAX
 PLACEMENT: 1.5" down from back neck seam to top of logo centered between straps

AVAILABLE PROCESSES:



R

FRONT

BACK

L

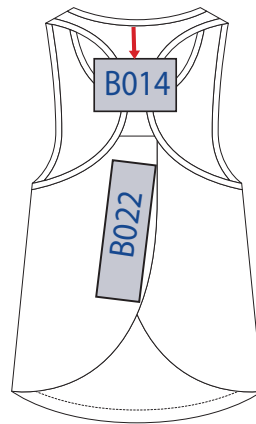
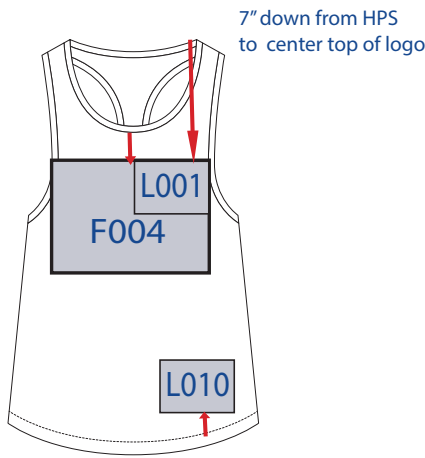

INFORMATION

- *Available in:
 - Adult XS - 3X
 - Youth YS - YL
- * 5.3 oz. 100% Cotton Garment -Dyed Jersey (Exclusive of decoration)
- * Self-neck/armhole bindings
- * Back yoke panel with racerback detail
- * Envelope back detail

SPECIAL INSTRUCTIONS

- * Screen print & Embroidery
- *no small details or distressed art for left chest or upper back center placements

L001 LEFT CHEST

ADULT : 3W x 3H MAX
 PLACEMENT : 6.5" down from HPS to top of logo

YOUTH: 2W x 2H MAX
 PLACEMENT : 6" down from HPS to top of logo

F004 FRONT CENTER

ADULT : 9W x 9H MAX
 PLACEMENT : 2" down from center neck seam to top of logo

YOUTH: 7W x 7H MAX
 PLACEMENT : 2" down from center neck seam to top of logo

B014 UPPER BACK CENTER

ADULT : 2W x 2H MAX
 PLACEMENT : 1.5" down from back neck seam to top of logo centered between straps

YOUTH: 1.5W x 1.5H MAX
 PLACEMENT: 1.5" down from back neck seam to top of logo centered between straps

B022 ENVELOPE HEM

ADULT : 2W x 12H MAX
 PLACEMENT : 1.5" down from back neck seam to top of logo, 1" from side vert seam

YOUTH: 1.5W x 10H MAX
 PLACEMENT: 1.5" down from back neck seam to top of logo, 1" from side vert seam

L010 SHIRT HEM

ADULT : 4W x 4H MAX
 PLACEMENT : 1" up from bottom seam to bottom of logo, 2" from side seam

YOUTH: 3W x 3H MAX
 PLACEMENT: 1" up from bottom seam to bottom of logo, 2" from side seam

AVAILABLE PROCESSES:

S **E**

S

S **E**

S

S

R

FRONT

BACK

L

INFORMATION

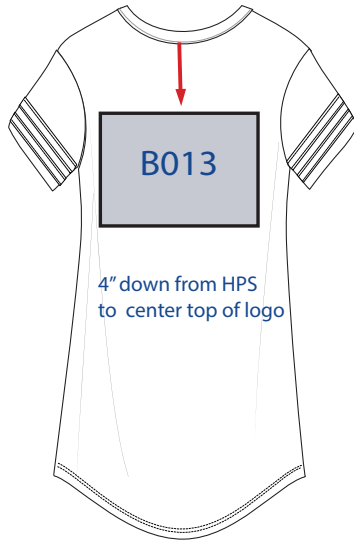

- *Available in:
Adult XS - 2X
- * 4.3 oz. 50/38/12 Poly/Cotton/Rayon Heather Tri-blend Jersey (Exclusive of decoration)
- * Self-band at neck
- * Lace-up V-neck
- * Twill drawcords
- * Self-contrasting sleeve stripes

SPECIAL INSTRUCTIONS

Screen print only

L001 LEFT CHEST

ADULT : 3W x3H MAX
PLACEMENT : 6.5" down from HPS to top of logo

F004 FRONT CENTER

ADULT : 9W x 9H MAX
PLACEMENT : 2" down from center neck seam to top of logo

B013 BACK CENTER

ADULT : 9W x 9H MAX
PLACEMENT: 4" down from bottom of the neck seam to top center of logo

AVAILABLE PROCESSES:



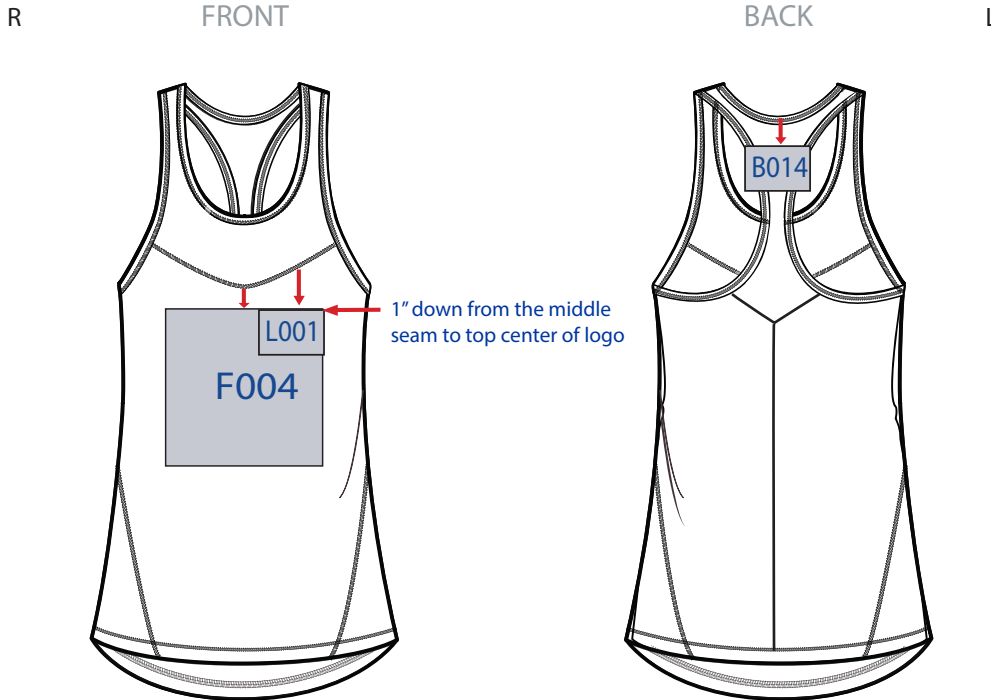

INFORMATION

- *Available in:
 Adult XS - 2X
 Youth YS - YL
- * 4.3 oz., 100%- Polyester
 Cationic-dyed jersey
- * Racerback
- * Scoop neckline
- * Curved bottom
- * Front yoke seam
- * Flare fit

SPECIAL INSTRUCTIONS

- Screen print only
- *no small details or distressed art for left chest or upper back center placements
- * PRODUCTION NOTE: USE WHITE ONE STROKE UNDERBASE

L001 LEFT CHEST

ADULT: 3W x 3H MAX
 PLACEMENT : .5" down from neck seam to top of logo centered between straps
 YOUTH: 2W x 2H MAX
 PLACEMENT : .5" down from neck seam to top of logo centered between straps

F004 FRONT CENTER

ADULT: 9W x 9H MAX
 PLACEMENT : 1" down from the middle seam to top center of logo centered
 YOUTH: 7W x 7H MAX
 PLACEMENT : 1" down from the middle seam to top center of logo centered

B014 UPPER BACK CENTER

ADULT: 2W x 2H MAX
 PLACEMENT : 1" down from the neck seam to top center of logo centered

AVAILABLE PROCESSES:



R FRONT BACK L

7" down from the HPS to the top of the logo

1.75" down from the bottom of the lowest point of the collar.

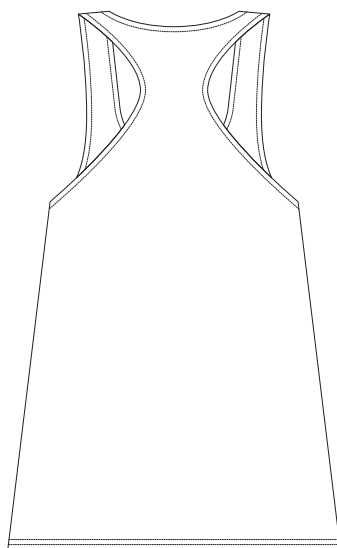
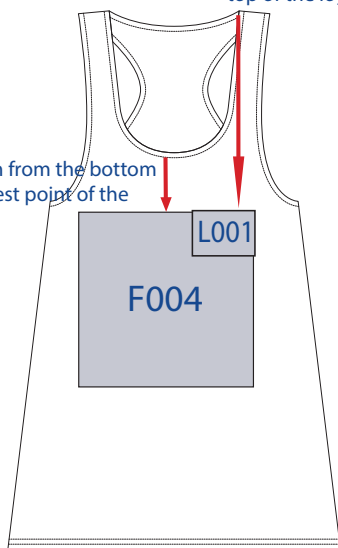

INFORMATION

- *Available in:
 - Adult XS-2X
 - BLACK, FUCHSIA, NAVY, ROYAL
 - * 4.3 oz., 100% Cotton jersey (exclusive of decoration)
 - CHARCOAL
 - * 4.3 oz., 50/50 Poly/Cotton jersey (exclusive of decoration)
 - MINT, PALE PINK
 - * 4.3 oz., 80/20% Poly/Cotton sueded jersey (exclusive of decoration)
 - * Racerback

SPECIAL INSTRUCTIONS

Screen print only
 *no small details or distressed art for left chest or upper back center placements

F004 FRONT CENTER

ADULT: 9W x 9H MAX
 PLACEMENT : Measured 1.75"-2" down from the bottom of the lowest point of the collar to the center of the logo

L001 LEFT CHEST

ADULT: 3W x 3H MAX
 PLACEMENT : Measured 8.5" down from the HSP to the top of the logo

AVAILABLE PROCESSES:



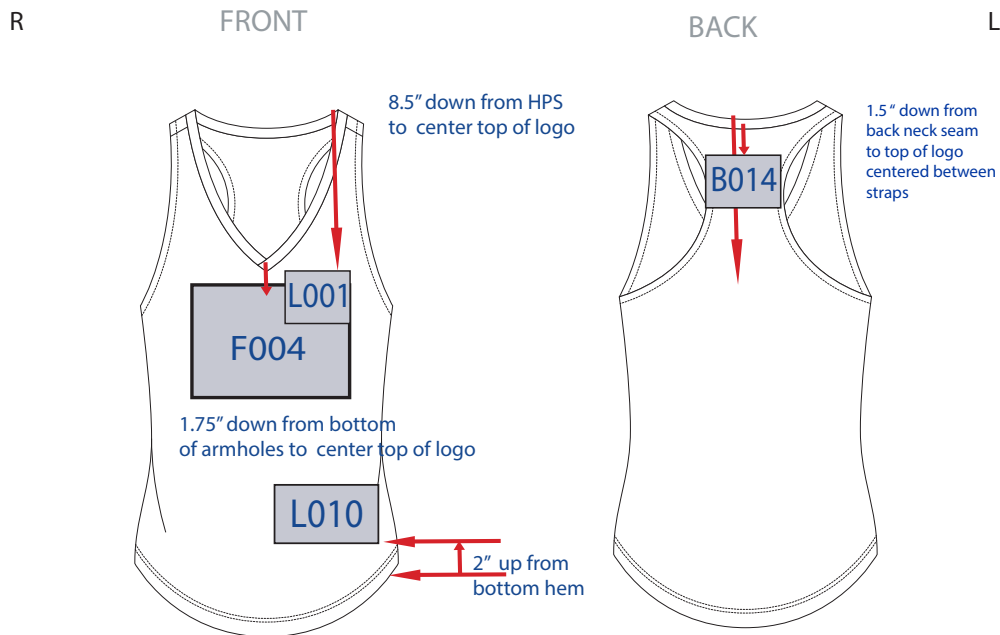

INFORMATION

- *Available in:
 - Adult XS - 2X
 - Youth YS - YL
- * 4.3 oz. 80/20 Polyester/Cotton
- * Bottom Hem Lightweight 100% Polyester Crepe
- * Short Sleeves Lightweight Printed Crepe Hem
- * Side Vents

SPECIAL INSTRUCTIONS

Screen print only
 *no small details or distressed art for left chest or upper back center placements

L001 LEFT CHEST

ADULT: 9W x 9H MAX
 PLACEMENT: 8.5" down from HPS to top of logo

YOUTH: 7W x 7H MAX
 PLACEMENT: 8.5" down from HPS to top of logo

F004 FRONT CENTER

ADULT: 3W x 3H MAX
 PLACEMENT: 1.75"-2" down from lowest point of the collar to top of logo centered

YOUTH: 2W x 2H MAX
 PLACEMENT: 1.75"-2" down from lowest point of the collar to top of logo centered

B014 UPPER BACK CENTER

ADULT: 3W x 3H MAX
 PLACEMENT: 1" down from the neck seam to top center of logo centered

YOUTH: 2W x 2H MAX
 PLACEMENT: 1" down from the neck seam to top center of logo centered

L010 SHIRT HEM

ADULT: 4W x 4H MAX
 PLACEMENT: 2" up from bottom hem

YOUTH: 3W x 3H MAX
 PLACEMENT: 2" up from bottom hem

AVAILABLE PROCESSES:



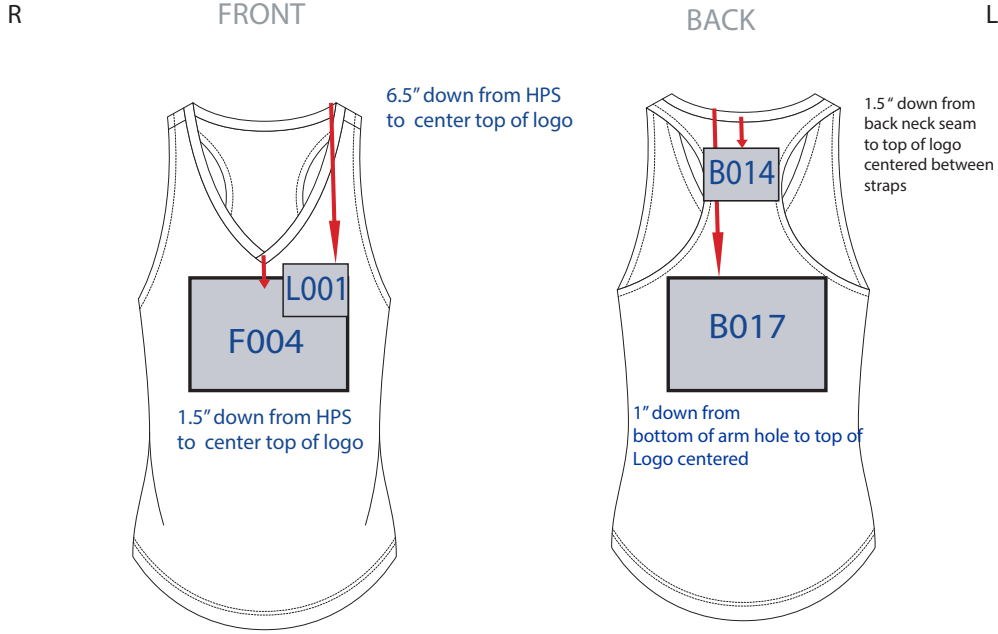

INFORMATION

- *Available in:
 - Adult XS - 2X
 - Youth YS - YL
- * 3.5 oz. 60/40 Cotton/ Poly Jersey Slub
- * Bottom Hem Lightweight 100% Polyester Crepe
- * Short Sleeves Lightweight Printed Crepe Hem
- * Side Vents

SPECIAL INSTRUCTIONS

Screen print only
 *no small details or distressed art for left chest or upper back center placements

L001 LEFT CHEST	ADULT: 3W x 3H MAX PLACEMENT: 6.5" down from HPS to top of logo
F004 FRONT CENTER	ADULT: 9W x 9H MAX PLACEMENT: 1.5" down from center neck seam to top of logo
B014 UPPER BACK CENTER	ADULT: 2W x 2H MAX PLACEMENT: 1" down from the neck seam to top center of logo centered
B017 LOWER BACK	ADULT: 9W x 3H MAX PLACEMENT: 1" down from the bottom of armhole to top center of logo centered

AVAILABLE PROCESSES:



R

FRONT

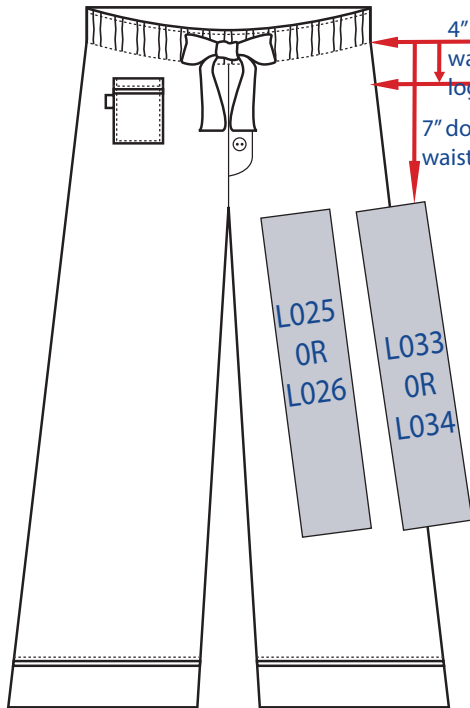

FRONT

L

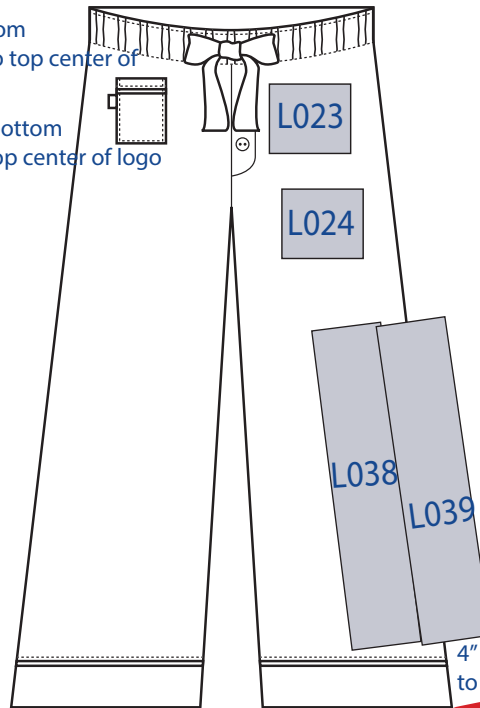

INFORMATION

- * Available in:
 - Adult XS - 2X
- * Womens Fit
- * 3.6oz 100% Seersucker OR Cotton Sheeting
- * Screen Print
- * Available in 9 colors
- * Satin Tie Cord Matches Satin Trim on Pockets and Cuffs
- * Contrast Inside Waistband
- * Right Front Pocket
- * Bottom Cuffs with Satin Trim
- * NO YOUTH

SPECIAL INSTRUCTIONS

L025 FRONT LEG-CENTER

ADULT: 4W x 18H MAX
 PLACEMENT: 7" down from bottom waistband to top of logo and centered on leg

L026 OVERSIZED

OVERSIZED: 5.5W x 24H MAX

L033 SIDE LEG

ADULT: 4W x 18H MAX
 PLACEMENT: 7" down from bottom waistband to top of logo at side seam

L034 OVERSIZED

OVERSIZED: 5.5W x 24H MAX

L023 HIP

ADULT: 3W x 3H MAX
 PLACEMENT: 4" down from bottom waistband to top of logo and centered on leg

L024 THIGH

ADULT: 4W x 4H MAX
 PLACEMENT: 7" down from bottom waistband to top of logo and centered on leg

L038 LOWER LEG-CENTER

ADULT: 4W x 18H MAX
 PLACEMENT: 2" up from bottom hem centered on leg

L039 LOWER SIDE LEG

ADULT: 4W x 18H MAX
 PLACEMENT: 2" up from bottom hem centered on leg

AVAILABLE PROCESSES:



R

FRONT

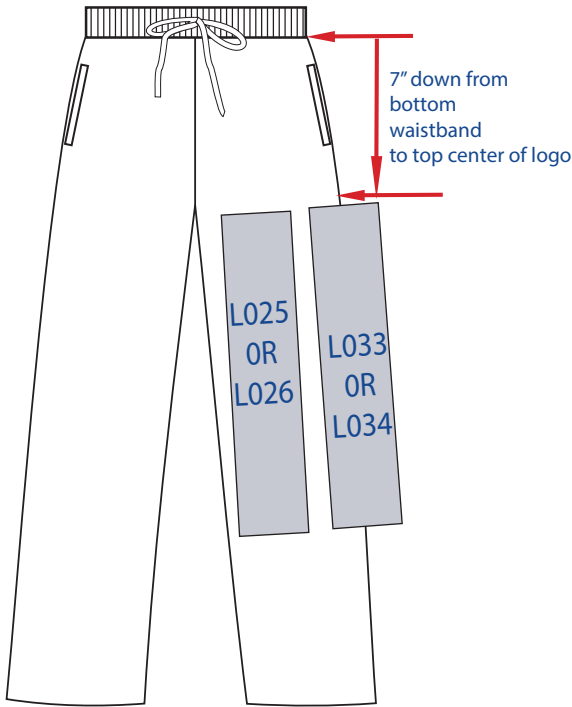

L

FRONT

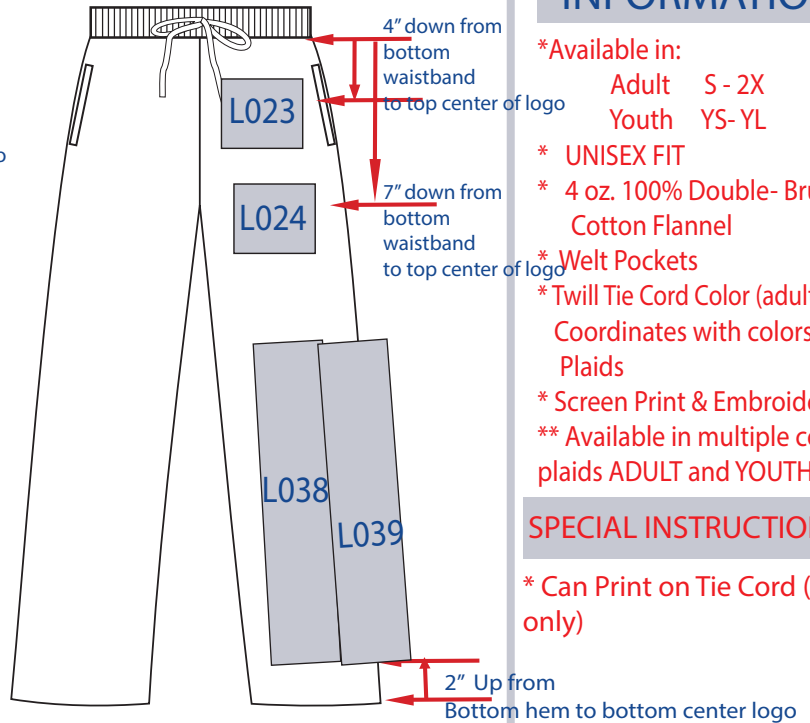

INFORMATION

- * Available in:
 - Adult S - 2X
 - Youth YS- YL
- * UNISEX FIT
- * 4 oz. 100% Double- Brushed Cotton Flannel
- * Welt Pockets
- * Twill Tie Cord Color (adult only)
- Coordinates with colors in Plaids
- * Screen Print & Embroidery
- ** Available in multiple color plaids ADULT and YOUTH

SPECIAL INSTRUCTIONS

- * Can Print on Tie Cord (adult only)

L025 FRONT LEG-CENTER
L026 OVERSIZED

ADULT: 4W x 18H MAX
 PLACEMENT : 7" down from bottom waistband to top of logo and centered on leg
 OVERSIZED: 5.5W x 24H MAX
 YOUTH: 3W x 17H MAX
 PLACEMENT : 6" down from bottom waistband to top of logo and centered on leg

L033 SIDE LEG
L034 OVERSIZED

ADULT: 4W x 18H MAX
 PLACEMENT : 7" down from bottom waistband to top of logo
 OVERSIZED: 5.5W x 24H MAX at side seam
 YOUTH: 3W x 17H MAX
 PLACEMENT : 6" down from bottom waistband to top of logo and centered on leg

L023 HIP

ADULT: 3W x 3H MAX
 PLACEMENT : 4" down from bottom waistband to top of logo and centered on leg
 YOUTH: 2.5W x 2.5H MAX
 PLACEMENT : 3" down from bottom waistband to top of logo

L024 THIGH

ADULT : 4W x 4H MAX
 PLACEMENT : 7" down from bottom waistband to top of logo and centered on leg
 YOUTH: 3W x 3H
 PLACEMENT : 6" down from bottom waistband to top of logo

L038 LOWER LEG-CENTER

ADULT : 4W x 18H MAX
 PLACEMENT : 2" up from bottom hem to bottom of logo and centered on leg
 YOUTH: 3W x 17 H MAX
 PLACEMENT : 2" up from bottom hem to bottom of logo

L039 LOWER SIDE LEG

ADULT: 4W x 4H MAX
 PLACEMENT : 2" up from bottom hem to bottom of logo at side leg
 YOUTH: 3W x 17H MAX
 PLACEMENT : 2" up from bottom hem to bottom of logo

AVAILABLE PROCESSES:

S

S

S E

S

S

S

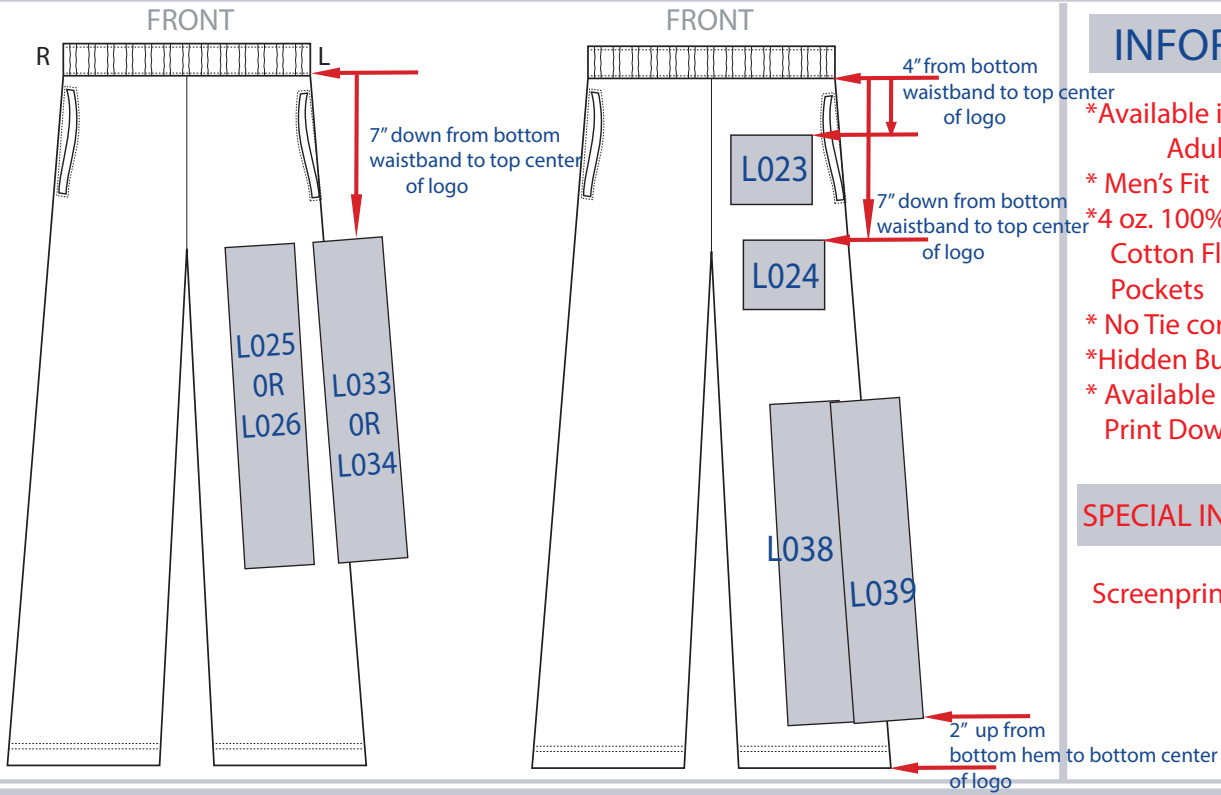

INFORMATION

- *Available in: Adult S - 2X
- * Men's Fit
- * 4 oz. 100% Double- Brushed Cotton Flannel, Welt Pockets
- * No Tie cord
- * Hidden Button-Close Fly
- * Available in OVERSIZE Print Down Leg ONLY

SPECIAL INSTRUCTIONS

Screenprint & Embroidery

L025 FRONT LEG-CENTER

ADULT: 4W x 18H MAX
 PLACEMENT: 7" down from bottom waistband to top of logo and centered on leg

L026 OVERSIZED

OVERSIZED: 5.5W x 24H MAX

L033 SIDE LEG

ADULT: 4W x 18H MAX
 PLACEMENT: 7" down from bottom waistband to top of logo at side seam

L034 OVERSIZED

OVERSIZED: 5.5W x 24H MAX

L023 HIP

ADULT: 3W x 3H MAX
 PLACEMENT: 4" down from bottom waistband to top of logo and centered on leg

L024 THIGH

ADULT: 4W x 4H MAX
 PLACEMENT: 7" down from bottom waistband to top of logo and centered on leg

L038 LOWER LEG-CENTER

ADULT: 4W x 18H MAX
 PLACEMENT: 2" up from bottom hem centered on leg

L039 LOWER SIDE LEG

ADULT: 4W x 18H MAX
 PLACEMENT: 2" up from bottom hem centered on leg

AVAILABLE PROCESSES:

S

S

S E

S

S

S

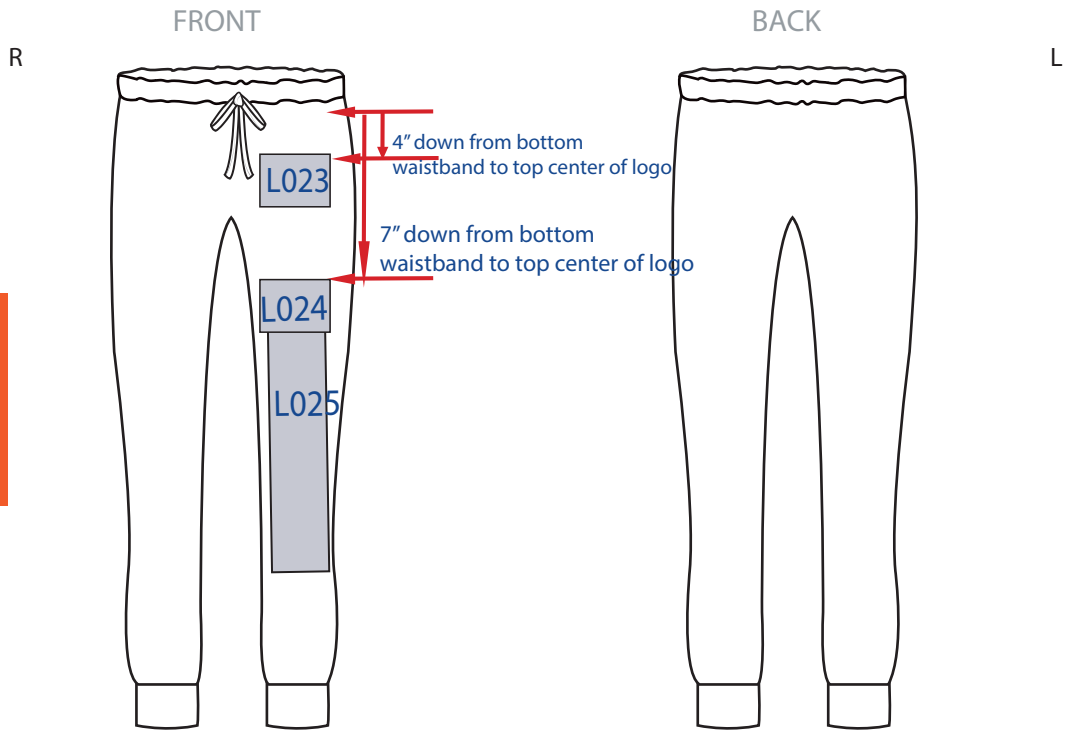

INFORMATION

- *Available in:
Adult XS - 2X
- * 4 oz. 100% Cotton Double Brushed Flannel
- * 1 x 1 Rib Waistband and 5/8" Cuffs in Contrasting Colors
- * Twill Tie Cord Matches Waistband Color

SPECIAL INSTRUCTIONS

- * Side Print not Available
- Screenprint & Embroidery

L023 HIP

ADULT : 3W x 3H MAX
 PLACEMENT : 4" down from waistband to top of logo and centered on leg

L024 THIGH

ADULT : 4W x 4H MAX
 PLACEMENT : 7" down from waistband to top of logo and centered on leg

L025 FRONT LEG-CENTER

ADULT : 4W x 18H MAX
 PLACEMENT : 7" down from waistband to top of logo centered on leg

AVAILABLE PROCESSES:

- S** **E**
- S**
- S**

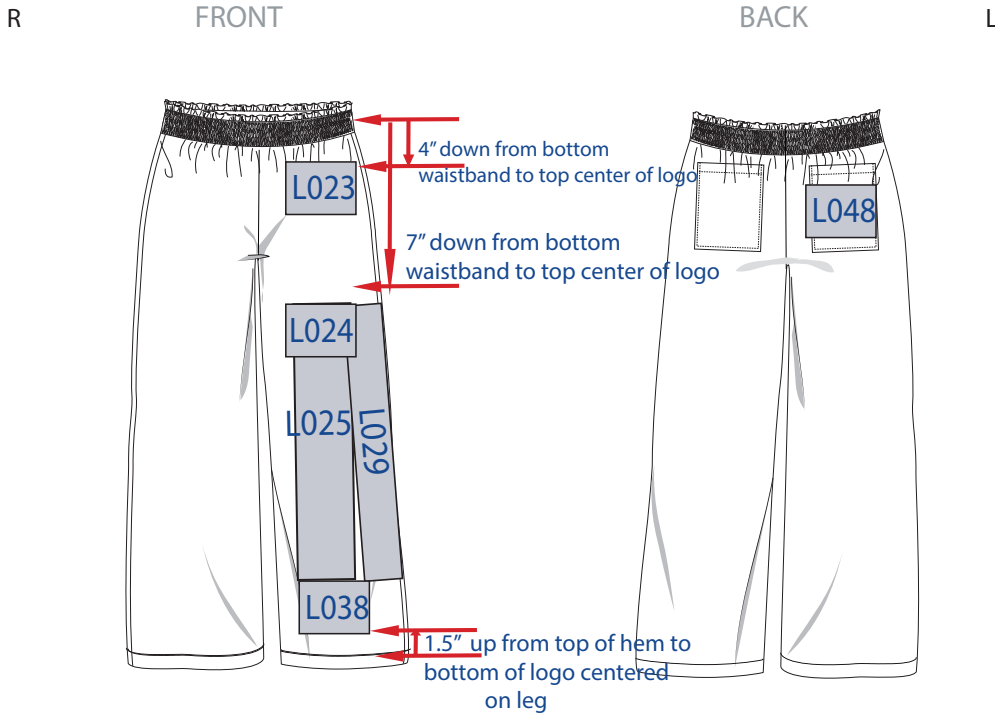

INFORMATION

- *Available in:
 - Adult XS - 2XL
 - Youth YS - YL
- * 4.2 oz., 50/38/12 polyester/cotton/ rayon striped heathered tri-blend jersey
- *Feminine wide smocked waistband with elastic stitching
- *Two back pockets

SPECIAL INSTRUCTIONS

- Screenprint only
- *No side print

L023	HIP	ADULT : 3W x 3H MAX PLACEMENT : 4" down from waistband to top of logo and centered on leg
L024	THIGH	ADULT : 4W x 4H MAX PLACEMENT : 7" down from waistband to top of logo and centered on leg YOUTH : 3W x 3H MAX PLACEMENT : 6" down from waistband to top of logo and centered on leg
L038	LOWER LEG-CENTER	ADULT : 4W x 18H MAX PLACEMENT : 1.5" up from bottom hem to bottom of logo centered on leg YOUTH : 3W x 17H MAX PLACEMENT : 1" up from bottom hem to bottom of logo centered on leg
L025	FRONT LEG-CENTER	ADULT : 4W x 18H MAX PLACEMENT : 7" down from waistband to top of logo centered on leg YOUTH : 3W x 17H MAX PLACEMENT : 7" down from waistband to top of logo centered on leg
L029	FRONT LEG-SIDE	ADULT : 4W x 18H MAX PLACEMENT : 7" down from waistband to top of logo, 2" from side seam YOUTH : 3W x 17H MAX PLACEMENT : 7" down from waistband to top of logo, 2" from side seam
L048	BACK POCKET	ADULT : 3W x 3H MAX PLACEMENT : centered on pocket YOUTH : 2W x 2H MAX PLACEMENT : centered on pocket

AVAILABLE PROCESSES:

S

S

S

S

S

S

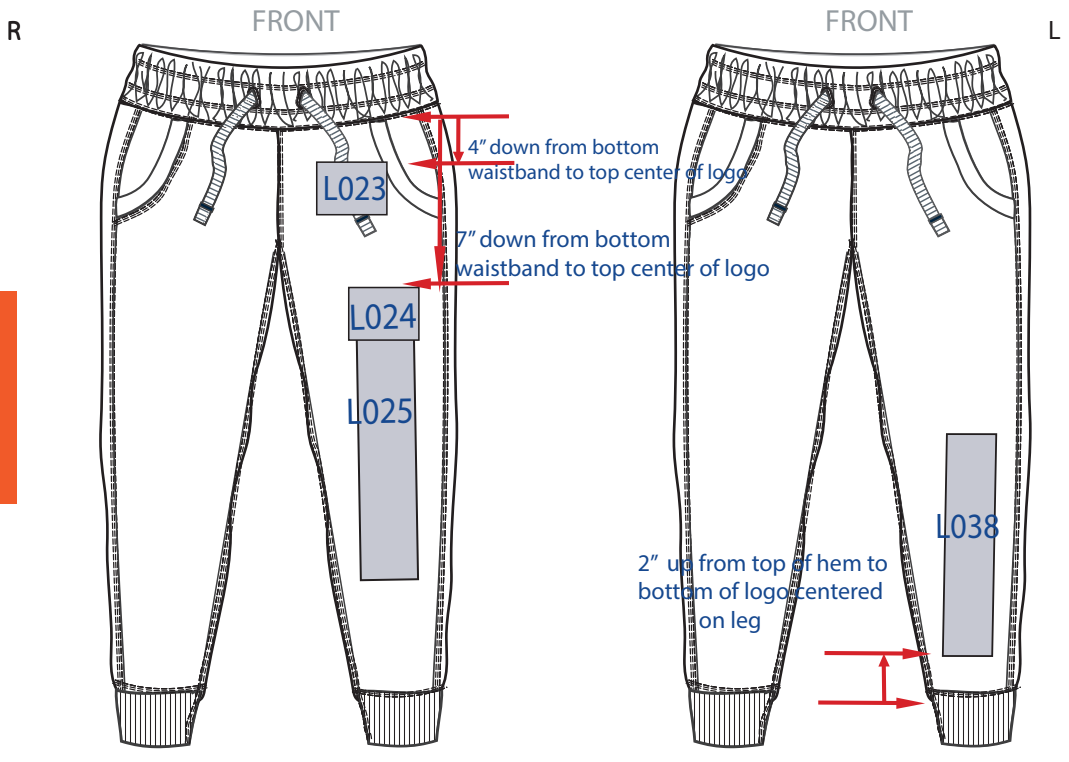

INFORMATION

- *Available in:
 - Adult XS - 2XL
 - Youth YS - YL
- * 6.5 oz., 60/40 Cotton Poly Fleece
- *Enzyme & stone wash for vintage look
- *Full-strength jogger with slim-fitting leg
- *Self-fabric covered elastic waistband
- *1x1 dyed to match rib cuffs
- *Dyed to match twill tie cord

SPECIAL INSTRUCTIONS

- *No side print available
- *No printing on the cuff
- * Screen print & Embroidery

L023 HIP

ADULT : 3W x 3H MAX
 PLACEMENT : 4" down from waistband to top of logo and centered on leg

YOUTH : 2W x 2H MAX
 PLACEMENT : 3" down from waistband to top of logo and centered on leg

L024 THIGH

ADULT : 4W x 4H MAX
 PLACEMENT : 7" down from waistband to top of logo and centered on leg

YOUTH : 3W x 3H MAX
 PLACEMENT : 6" down from waistband to top of logo and centered on leg

L038 LOWER LEG-CENTER

ADULT : 3W x 17H MAX
 PLACEMENT : 2" up from bottom hem to bottom of logo centered on leg

YOUTH : 2W x 15H MAX
 PLACEMENT : 2" up from bottom hem to bottom of logo centered on leg

L025 FRONT LEG-CENTER

ADULT : 4W x 18H MAX
 PLACEMENT : 7" down from waistband to top of logo centered on leg

YOUTH : 3W x 17H MAX
 PLACEMENT : 6" down from waistband to top of logo centered on leg

AVAILABLE PROCESSES:

S **E**

S

S

S

R

FRONT

L

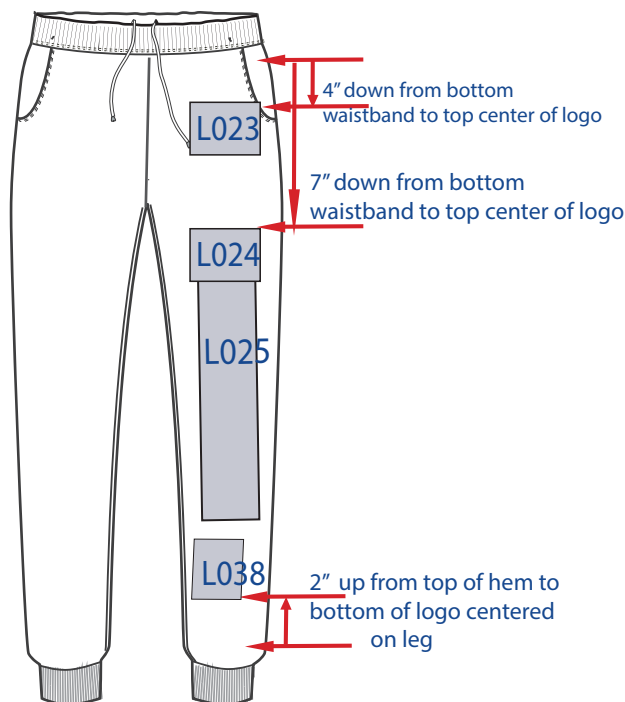

INFORMATION

- * Available in:
 - Adult S - 2XL
 - Youth YS - YL
- * 7 oz. 60/40 Cotton Poly Fleece
- * Rib Cuffs
- * Inside Tie Cord Matches Garment Color
- * Side Seam Pockets

SPECIAL INSTRUCTIONS

- * No Side Print

L023 HIP

ADULT : 3W x 3H MAX
 PLACEMENT : 4" down from waistband to top of logo and centered on leg

YOUTH : 2W x 2H MAX
 PLACEMENT : 3" down from waistband to top of logo and centered on leg

L024 THIGH

ADULT : 4W x 4H MAX
 PLACEMENT : 7" down from waistband to top of logo and centered on leg

YOUTH : 3W x 3H MAX
 PLACEMENT : 6" down from waistband to top of logo and centered on leg

L038 LOWER LEG-CENTER

ADULT : 4W x 18H MAX
 PLACEMENT : 2" up from bottom hem to bottom of logo centered on leg

YOUTH : 3W x 17H MAX
 PLACEMENT : 2" up from bottom hem to bottom of logo centered on leg

L025 FRONT LEG-CENTER

ADULT : 4W x 18H MAX
 PLACEMENT : 7" down from waistband to top of logo centered on leg

YOUTH : 3W x 17H MAX
 PLACEMENT : 6" down from waistband to top of logo centered on leg

AVAILABLE PROCESSES:

S E

S

S

S

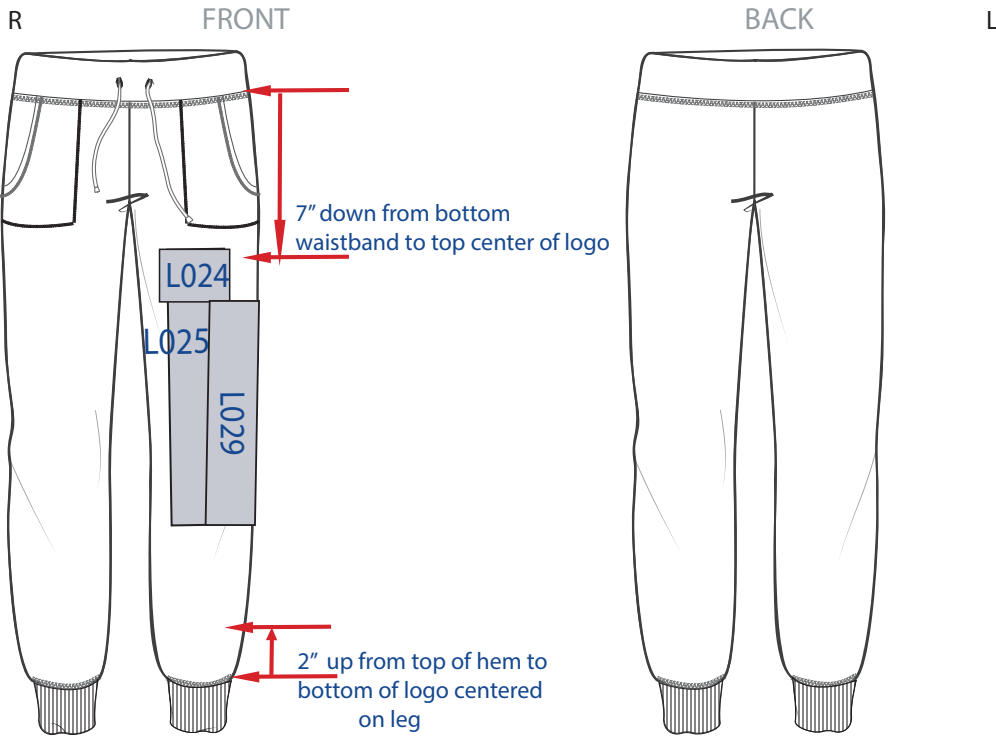

INFORMATION

- *Available in:
Adult XS- 2X
- * Womens
- * 5.9 oz , 80/17/3 Viscose/Polyester/
Elastane Cuddle Knit
(exclusive of decoration)
- * Self waistband w/self drawcords
finished with knot
- * Rib cuff at leg opening

SPECIAL INSTRUCTIONS

PRINT OPTIONS:
Screen print only

L024 THIGH

ADULT : 4W x 4H MAX
 PLACEMENT : 7" down from waistband to top of logo and centered on leg
 YOUTH : 3W x 3H MAX
 PLACEMENT : " down from waistband to top of logo and centered on leg

L025 FRONT LEG-CENTER

ADULT : 4W x 18H MAX
 PLACEMENT : 7" down from waistband to top of logo centered on leg
 ADULT : 3W x 17H MAX
 PLACEMENT : 7" down from waistband to top of logo 1" over from side seam

L029 FRONT LEG-SIDE

ADULT : 4W x 18H MAX
 PLACEMENT : 7" down from waistband to top of logo centered on leg
 ADULT : 3W x 17H MAX
 PLACEMENT : 7" down from waistband to top of logo 1" over from side seam

AVAILABLE PROCESSES:



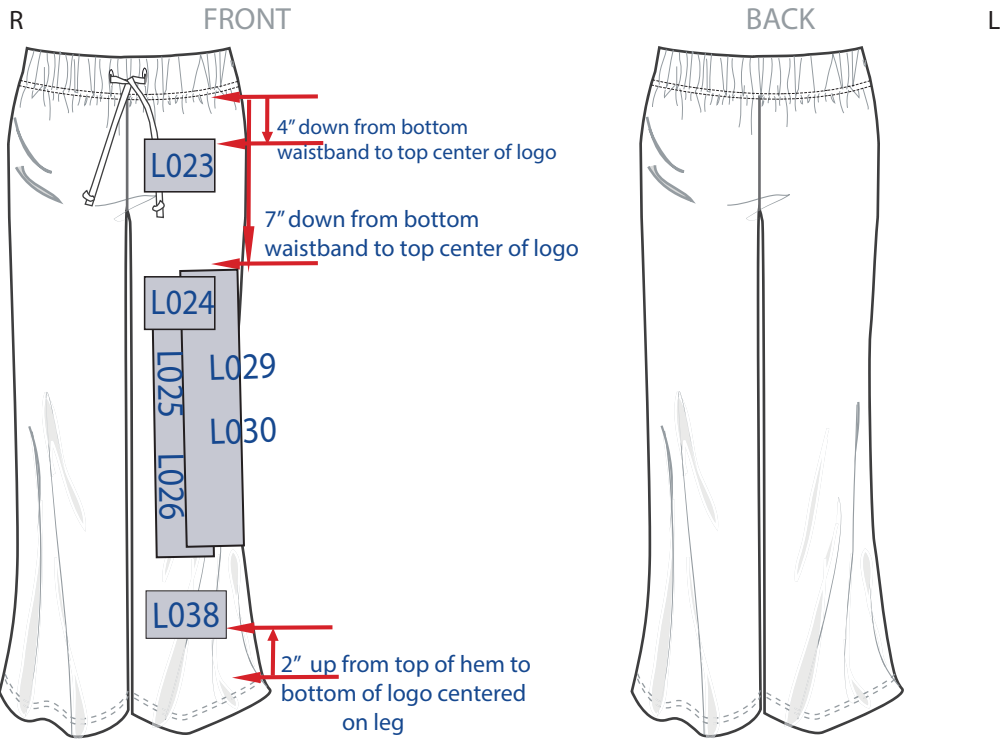

INFORMATION

- * Available in:
Adult XS- 2X
- * Womens
- * 5.9 oz , 80/17/3 Viscose/Polyester/
Elastane Cuddle Knit
(exclusive of decoration)
- * Self waistband w/self drawcords
finished with knot
- * Wide leg fit

SPECIAL INSTRUCTIONS

PRINT OPTIONS:
Screen print & Embroidery

L023 HIP

ADULT : 3W x 3H MAX
PLACEMENT : 4" down from waistband to top of logo and centered on leg

L024 THIGH

ADULT : 4W x 4H MAX
PLACEMENT : 7" down from waistband to top of logo and centered on leg

L038 LOWER LEG-CENTER

ADULT : 4W x 18H MAX
PLACEMENT : 2" up from bottom hem to bottom of logo centered on leg

L025 FRONT LEG-CENTER

ADULT : 4W x 18H MAX
PLACEMENT : 7" down from waistband to top of logo centered on leg

L026 OVERSIZED

ADULT : 5.5W x 24H MAX
PLACEMENT : 7" down from waistband to top of logo, 2" from side seam

L029 FRONT LEG-SIDE

ADULT : 4W x 18H MAX
PLACEMENT : 7" down from waistband to top of logo, 2" from side seam

L030 OVERSIZED

ADULT : 5.5W x 24H MAX
PLACEMENT : 7" down from waistband to top of logo, 2" from side seam

AVAILABLE PROCESSES:

S E

S

S

S

S

S

S

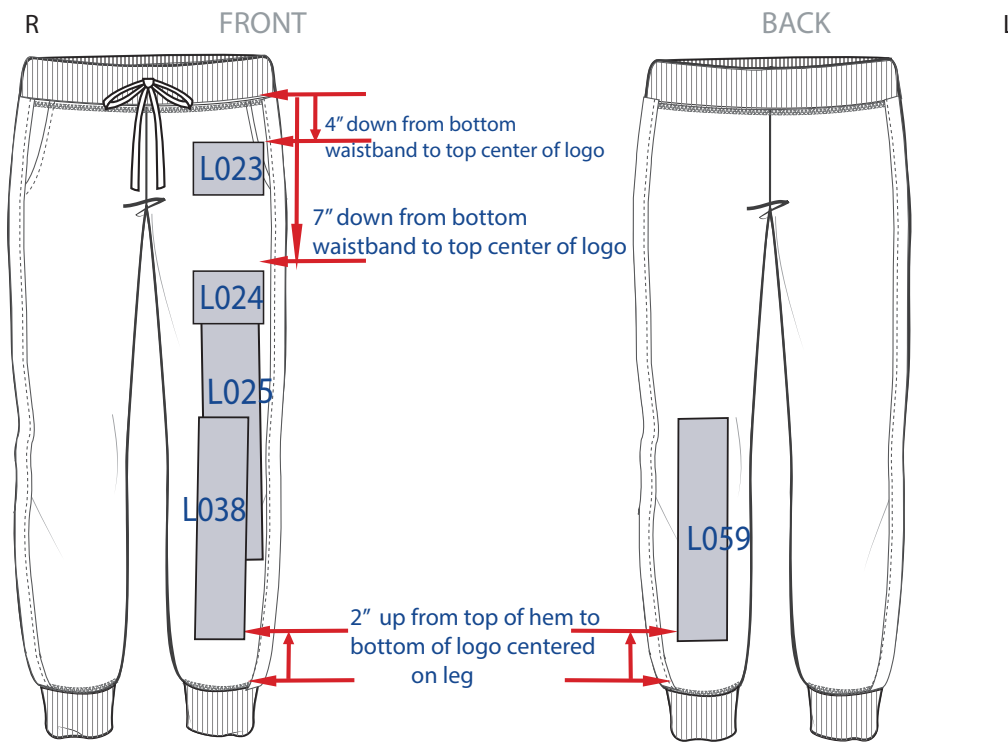

INFORMATION

- *Available in:
 Adult XS- 2X
 Youth YS-YL
- * Womens
- * 8.3 oz , 70/30 cotton/polyester french terry (exclusive of decoration)
- * Rib waistband
- * Twill tape drawcord (adult only)
- * (2) Self side stripes
- * Slash pockets
- * Rib cuffs at leg opening

SPECIAL INSTRUCTIONS

- PRINT OPTIONS:**
 Screen print & embroidery
 * No side prints

L023 HIP

ADULT : 3W x 3H MAX
 PLACEMENT : 4" down from waistband to top of logo and centered on leg

YOUTH: 2W x 2H MAX
 PLACEMENT : 3" down from waistband to top of logo and centered on leg

L024 THIGH

ADULT : 4W x 4H MAX
 PLACEMENT : 7" down from waistband centered on leg

YOUTH: 3W x 3H MAX
 PLACEMENT : 6" down from waistband to top of logo centered on leg

L038 LOWER LEG-CENTER

ADULT : 3W x 14H MAX
 PLACEMENT : 2" up from bottom hem centered on leg

YOUTH: 2W x 12H MAX
 PLACEMENT : 2" up from bottom hem to top of logo and centered on leg

L025 FRONT LEG-CENTER

ADULT : 4W x 18H MAX
 PLACEMENT : 7" down from waistband to top of logo centered on leg

YOUTH: 3W x 17H MAX
 PLACEMENT : 6" down from waistband to top of logo centered on leg

L059 BACK LEG HEM

ADULT : 3W x 14H MAX
 PLACEMENT : 2" up from bottom hem to bottom of logo, centered

YOUTH: 2W x 12H MAX
 PLACEMENT : 2" up from bottom hem to bottom of logo, centered

AVAILABLE PROCESSES:

S E

S

S

S

S

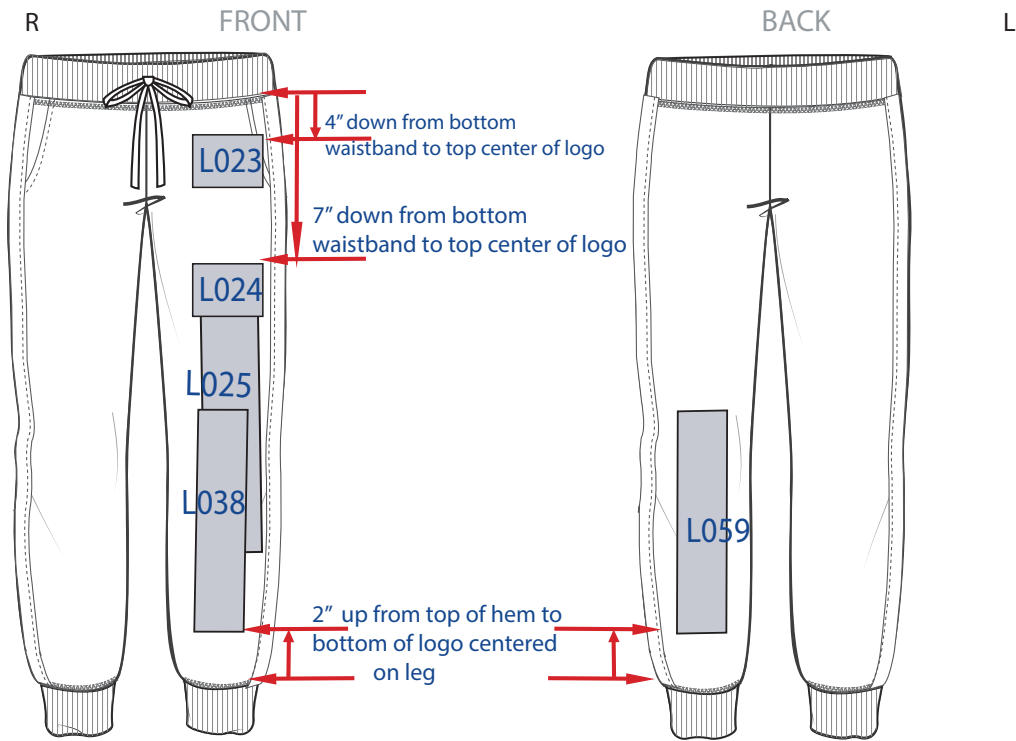

INFORMATION

- *Available in:
Adult S- 2X
- * Mens
- * 8.3 oz , 70/30 cotton/polyester french terry (exclusive of decoration)
- * Rib waistband
- * Twill tape drawcord
- * (2) Self side stripes
- * Slash pockets
- * Rib cuffs at leg opening

SPECIAL INSTRUCTIONS

- PRINT OPTIONS:**
- Screen print & embroidery
 - * No side prints

L023 HIP

ADULT : 3W x 3H MAX
 PLACEMENT : 4" down from waistband to top of logo and centered on leg

L024 THIGH

ADULT : 4W x 4H MAX
 PLACEMENT : 7" down from waistband to top of logo and centered on leg

L038 LOWER LEG-CENTER

ADULT : 3W x 14H MAX
 PLACEMENT : 2" up from bottom hem to bottom of logo centered on leg

L025 FRONT LEG-CENTER

ADULT : 4W x 18H MAX
 PLACEMENT : 7" down from waistband to top of logo centered on leg

L059 BACK LEG HEM

ADULT : 3W x 14H MAX
 PLACEMENT : 2" up from bottom hem to bottom of logo, centered

AVAILABLE PROCESSES:

S E

S

S

S

S

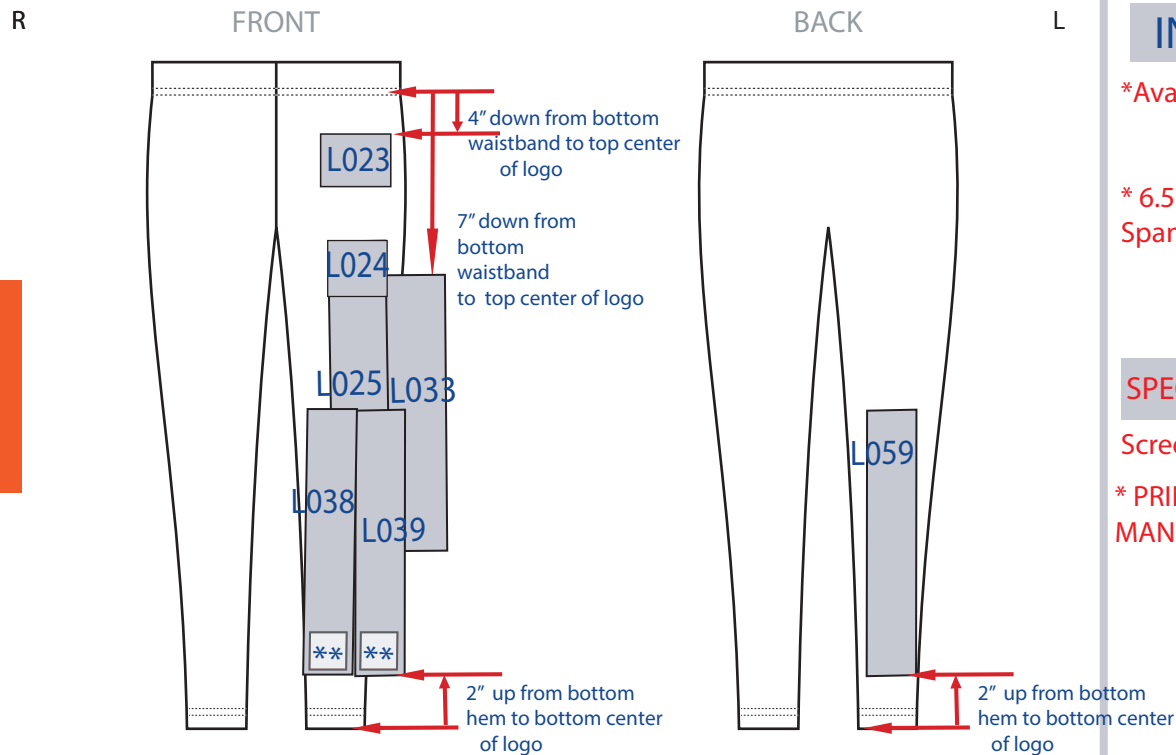

INFORMATION

*Available in:
 Adult XS - 2XL
 Youth YS - YL
 * 6.5 oz 90 / 10 Cotton Spandex

SPECIAL INSTRUCTIONS

Screenprint only
 * PRINT OPTIONS:
 MANUAL PRESS ONLY

L023 HIP

ADULT : 3W x 3H MAX
 PLACEMENT : 4" down from waistband to top of logo and centered on leg
 YOUTH: 2W x 2H MAX
 PLACEMENT : 3" down from waistband to top of logo and centered on leg

L024 THIGH

ADULT : 4W x 4H MAX
 PLACEMENT : 6" down from waistband centered on leg
 YOUTH: 3W x 3H MAX
 PLACEMENT : 5" down from waistband to top of logo centered on leg

L038 LOWER LEG-CENTER

ADULT : 3W x 17H MAX
 PLACEMENT : 2" up from bottom hem centered on leg
 YOUTH: 2W x 10H MAX
 PLACEMENT : 2" up from bottom hem to top of logo and centered on leg

L039 LOWER SIDE LEG

ADULT : 3W x 17H MAX
 PLACEMENT : 2" up from bottom hem to bottom of logo, 2" from side
 YOUTH: 2W x 10H MAX
 PLACEMENT : 2" up from bottom hem to bottom of logo, 2" from side

L025 FRONT LEG-CENTER

ADULT : 4W x 18H MAX
 PLACEMENT : 7" down from waistband to top of logo centered on leg
 YOUTH: 2W x 10H MAX
 PLACEMENT : 6" down from waistband to top of logo centered on leg

L033 SIDE LEG

ADULT : 4W x 18H MAX
 PLACEMENT : 2" up from bottom hem to bottom of logo, 2" from side
 YOUTH: 2W x 10H MAX
 PLACEMENT : 2" up from bottom hem to bottom of logo, 2" from side

L059 BACK LEG HEM

ADULT : 3W x 17H MAX
 PLACEMENT : 2" up from bottom hem to bottom of logo, centered
 YOUTH: 2W x 10H MAX
 PLACEMENT : 2" up from bottom hem to bottom of logo, centered

AVAILABLE PROCESSES:

- S
- S
- S
- S
- S
- S
- S

R

FRONT

BACK

L

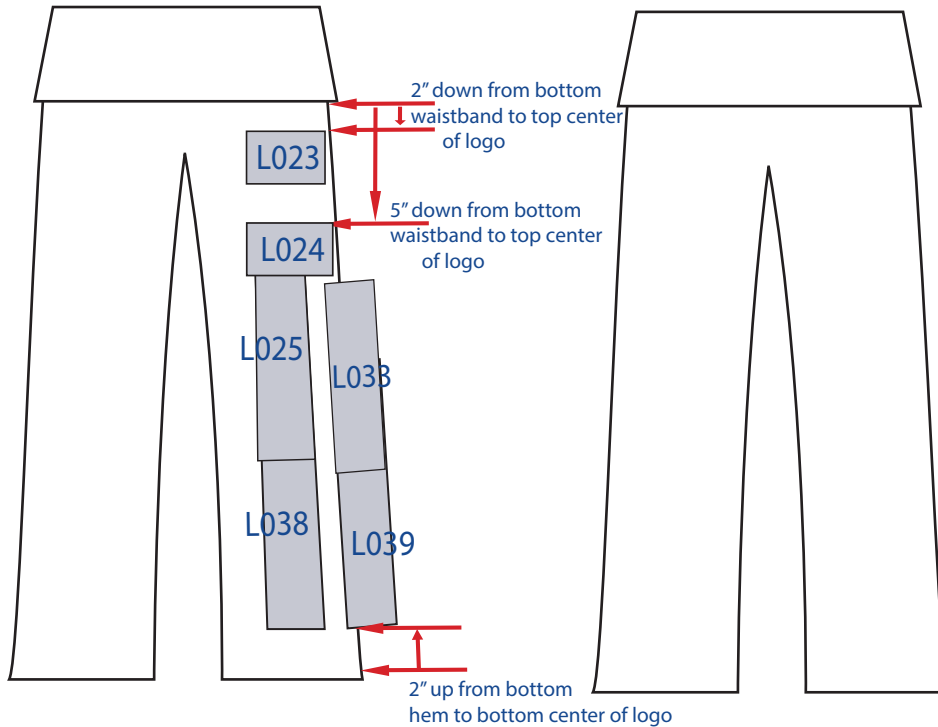

INFORMATION

- *Available in:
 - Adult XS - 2XL
 - Youth YS - YL
- * 6.5 oz 90/10 Cotton / Spandex
- * Fold Over Waistband

SPECIAL INSTRUCTIONS

- *Screen print only
- *** PRINT OPTION: MANUAL PRESS ONLY

L023 HIP

ADULT : 3W x 3H MAX
 PLACEMENT : 4" down from waistband to top of logo and centered on leg
 YOUTH: 2W x 2H MAX
 PLACEMENT : 3" down from waistband

L024 THIGH

ADULT : 4W x 4H MAX
 PLACEMENT : 7" down from waistband centered on leg
 YOUTH: 3W x 3H MAX
 PLACEMENT : 6" down from waistband to top of logo

L038 LOWER LEG-CENTER

ADULT : 4W x 18H MAX
 PLACEMENT : 2" up from bottom hem centered on leg
 YOUTH: 3W x 17H MAX
 PLACEMENT : 2" up from bottom hem

L039 LOWER SIDE LEG

ADULT : 4W x 18H MAX
 PLACEMENT : 2" up from hem and centered on seam
 YOUTH: 3W x 17H MAX
 PLACEMENT : 2" up from bottom hem

L025 FRONT LEG-CENTER

ADULT : 4W x 18H MAX
 PLACEMENT : 7" down from waistband, centered on leg
 YOUTH: 3W x 17H MAX
 PLACEMENT : 6" down from waistband, centered on leg

L033 SIDE LEG

ADULT : 4W x 18H MAX
 PLACEMENT : 7" down from waistband, centered on leg
 YOUTH: 3W x 17H MAX
 PLACEMENT : 6" down from waistband, centered on leg

AVAILABLE PROCESSES:

S

S

S

S

S

S

R

FRONT

BACK

L

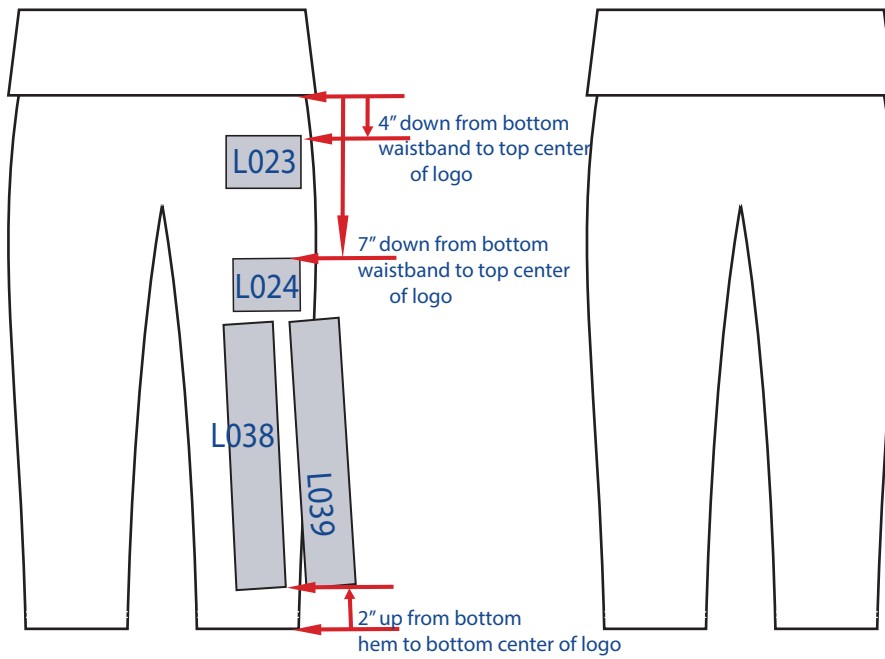

INFORMATION

- *Available in:
 - Adult XS - 2XL
 - Youth YS - YL
- * 6.5 oz 90/10 Cotton / Spandex
- * Fold Over Waistband
- * SIDE SEAM

SPECIAL INSTRUCTIONS

- * Side Print Available
- * HEAT / MANUAL PRESS ONLY

L023 HIP

ADULT : 3W x 3H MAX
 PLACEMENT : 4" down from waistband to top of logo and centered on leg
 YOUTH: 2W x 2H MAX
 PLACEMENT : 3" down from waistband

L024 THIGH

ADULT : 4W x 4H MAX
 PLACEMENT : 7" down from waistband centered on leg
 YOUTH: 3W x 3H MAX
 PLACEMENT : 6" down from waistband to top of logo

L038 LOWER LEG-CENTER

ADULT : 4W x 15H MAX
 PLACEMENT : 2" up from bottom hem centered on leg
 YOUTH: 2W x 14H MAX
 PLACEMENT : 2" up from bottom hem

L039 LOWER SIDE LEG

ADULT : 4W x 15H MAX
 PLACEMENT : 2" up from hem and centered on seam
 YOUTH: 2W x 14H MAX
 PLACEMENT : 2" up from bottom hem

AVAILABLE PROCESSES:



R

FRONT

L

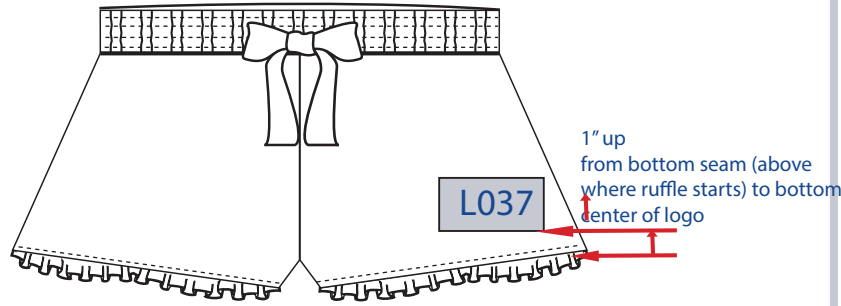

INFORMATION

- * Available in: Adult XS - 2X
- * Women's Fit
- * 3.6oz 100% Cotton Seersucker
- * 1 3/4" inseam
- * Satin Ribbon Tie Cord and inside waistband Color Coordinates with Fabric
- * Self Fabric Ruffle Hem
- * Screen Print & embroidery

SPECIAL INSTRUCTIONS

- * No small detail or distressed art

L037 LEFT LEG HEM

ADULT: 3W x 3H MAX
 PLACEMENT: 1" up from bottom hem (before ruffle starts) to bottom of logo centered on leg & 2" from side seam

AVAILABLE PROCESSES:



R

FRONT

L

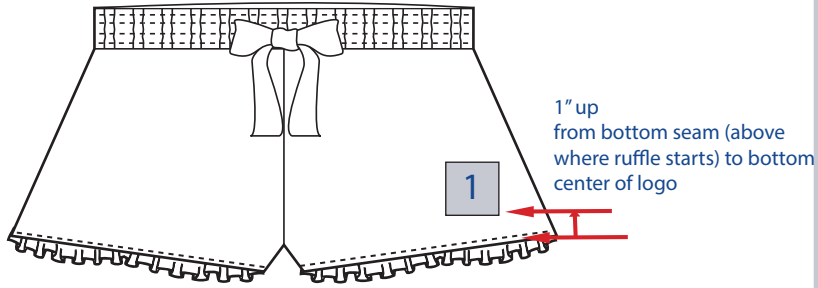

INFORMATION

- *Available in:
 - Adult XS - XL
 - Youth YS - YL
- * Women's Fit
- * 4 oz. 100% Double-Brushed Cotton Flannel
- * Satin Ribbon Tie Cord and Inside Waistband Color Coordinates with Print Color
- * Self Fabric Ruffle Hem
- * Screen Print
- ** Youth offered in limited colors

SPECIAL INSTRUCTIONS

- *No small detail or distressed art

L037

HEM

ADULT: 3W x 3H MAX

PLACEMENT: 1" up from bottom hem (before ruffle starts) to bottom of logo centered on leg & 2" from side seam

YOUTH: 2W x 2W MAX

PLACEMENT: 1" up from bottom hem (before ruffle starts) to bottom of logo centered on leg & 2" from side seam

AVAILABLE PROCESSES:



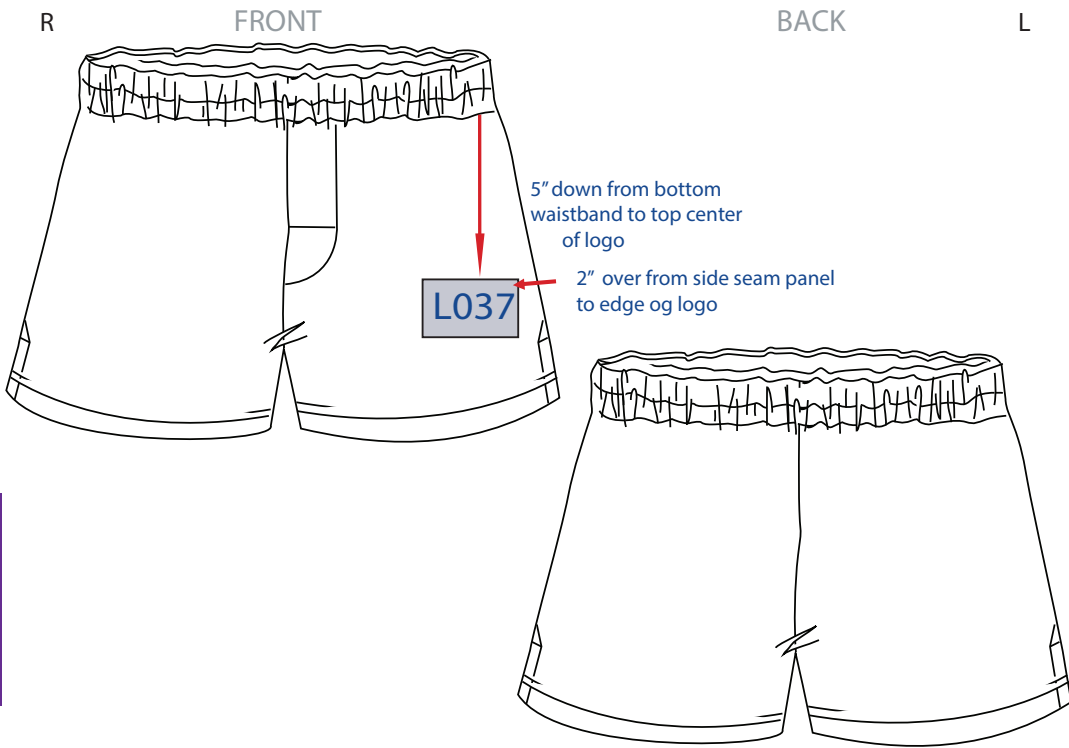

INFORMATION

*Available in:
Adult XS- 2X

- * Ladies
- * 4.3 oz, double nruhed cotton flannel (exclusive of decoration)
- * Shirred waistband
- * Faux Fly decorative stitching
- * Side vent with decorative twill tape at interior.

SPECIAL INSTRUCTIONS

PRINT OPTIONS:
Screen print & embroidery
* No small details or distressed art

L037 HEM

ADULT : 3W x 3H MAX
PLACEMENT : 5" down from bottom waistband to top of logo
2" over from side seam panel to side of logo

AVAILABLE PROCESSES:



R

FRONT

L

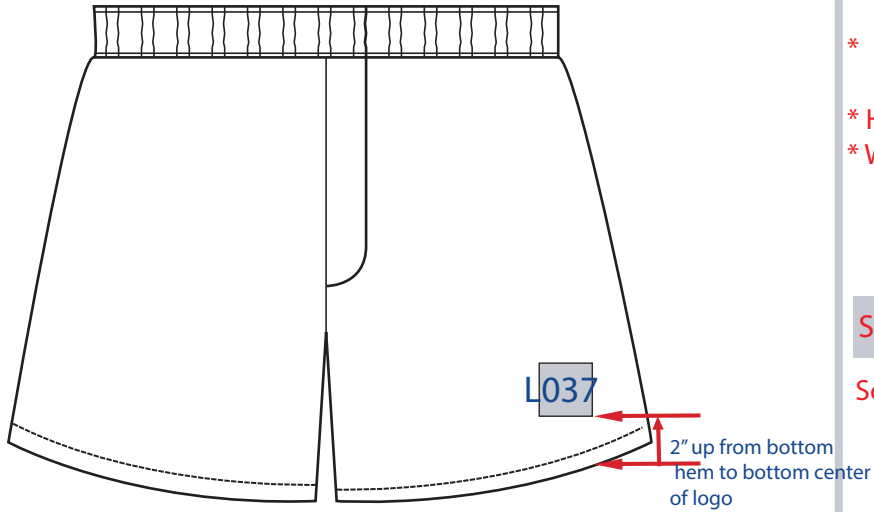

INFORMATION

- *Available in:
Adult XS - XL
- * 4 oz. 100% Double Brushed Cotton Flannel
- * Hidden Working Fly
- * White Plush Inside Elastic Waistband

SPECIAL INSTRUCTIONS

Screenprint & Embroidery

*No small detail or distressed art

L037 HEM

ADULT: 3 W x 3 H
 PLACEMENT: 2" up from bottom hem to bottom of logo

AVAILABLE PROCESSES:



R

FRONT

L

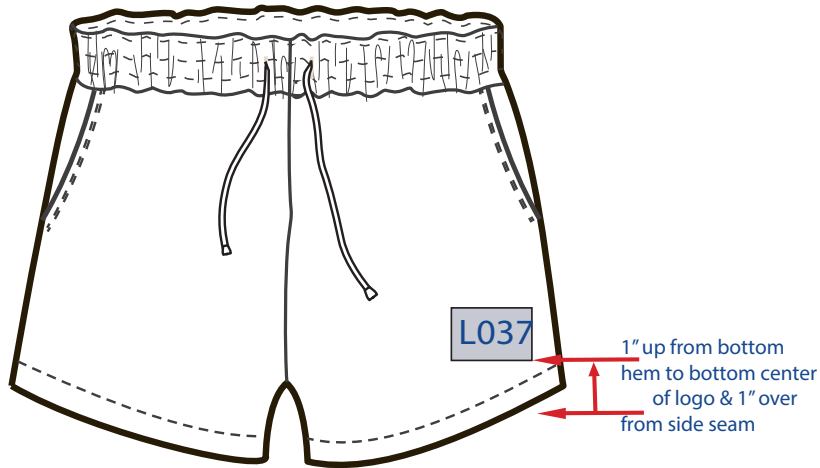

INFORMATION

- *Available in:
 - Adult XS - 2X
 - Youth YS - YL
- * 60/40 Cotton Poly Enzyme and Stone Wash Fleece
- * Canvas Color Rope Tie Cord
- * Covered Elastic Waistband
- * Finished Hem
- * Side Seam Pockets

SPECIAL INSTRUCTIONS

- *Screen print & embroidery
- *No small detail or distressed art

L037 HEM

ADULT: 3W x 3H
 PLACEMENT: 1" up from bottom hem to bottom of logo centered on leg
 2" from the side seam
 YOUTH: 2W x 2H
 PLACEMENT: 1" up from bottom hem to bottom of logo centered on leg
 1" from the side seam



AVAILABLE PROCESSES:

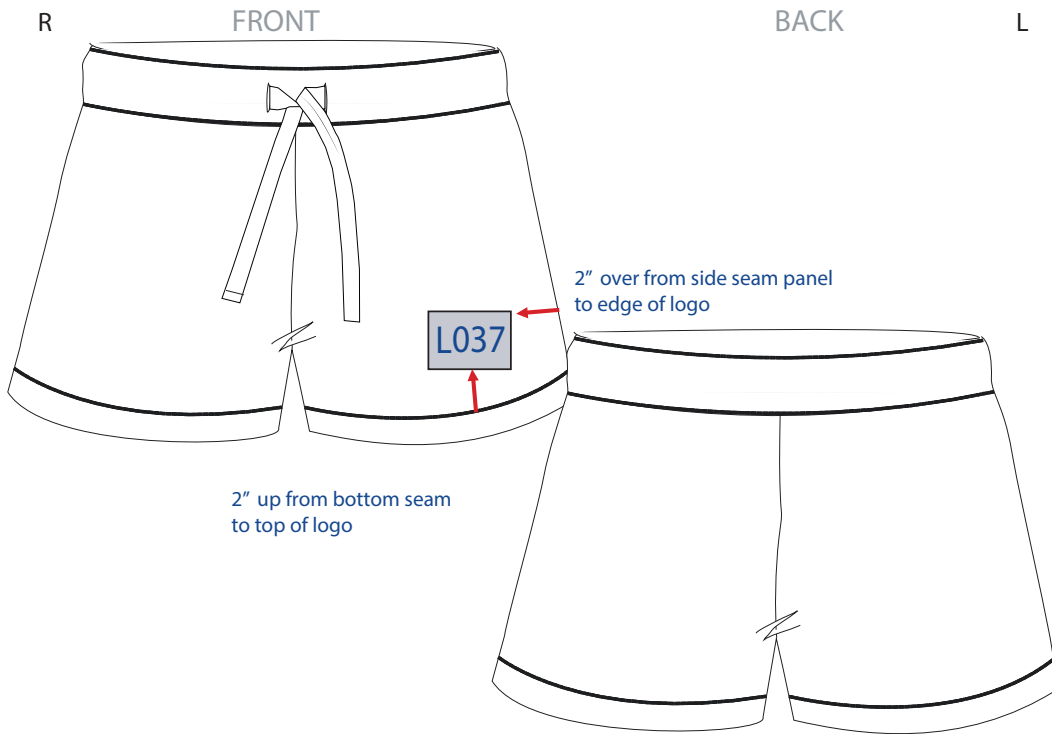

INFORMATION

- *Available in:
Adult XS- 2X
- * 5.9 oz 80/17/3 Viscose/Polyester/
Elastane Brushed Hacci Knit
(Exclusive of decoration)
- * Folded Waistband
- * Twill Drawcord

SPECIAL INSTRUCTIONS

- PRINT OPTIONS:**
Screen print &
embroidery
* No small details or
distressed art

L037 LEFT LEG HEM

ADULT : 3 W x 3 H MAX
PLACEMENT : 5" down from bottom waistband to top of logo
2" over from side seam panel to side of logo

AVAILABLE PROCESSES:



R

FRONT

L

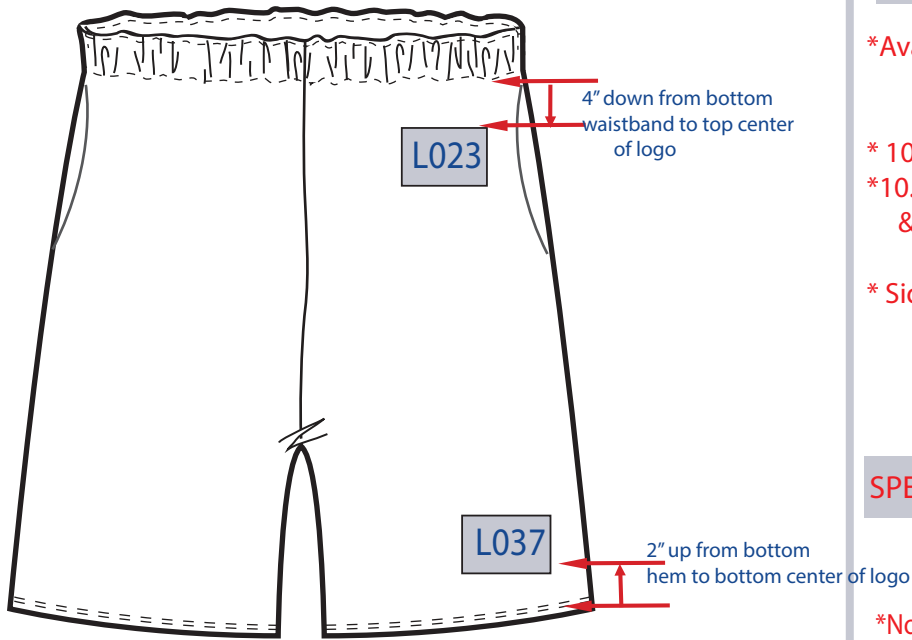

INFORMATION

- * Available in:
 - Adult S - 2XL
 - Youth YS - YL
- * 100% Polyester Mesh
- * 10.5" Inseam with Pockets & Inside adjustable Drawstring
- * Side Seam Pockets

SPECIAL INSTRUCTIONS

- * No small detail or distressed art

L037 HEM

ADULT : 4 W x 4 H MAX
 PLACEMENT : 2" Up from bottom hem

L023 HIP

ADULT : 3W x 3H MAX
 PLACEMENT : 4" down from waistband

AVAILABLE PROCESSES:

S

S

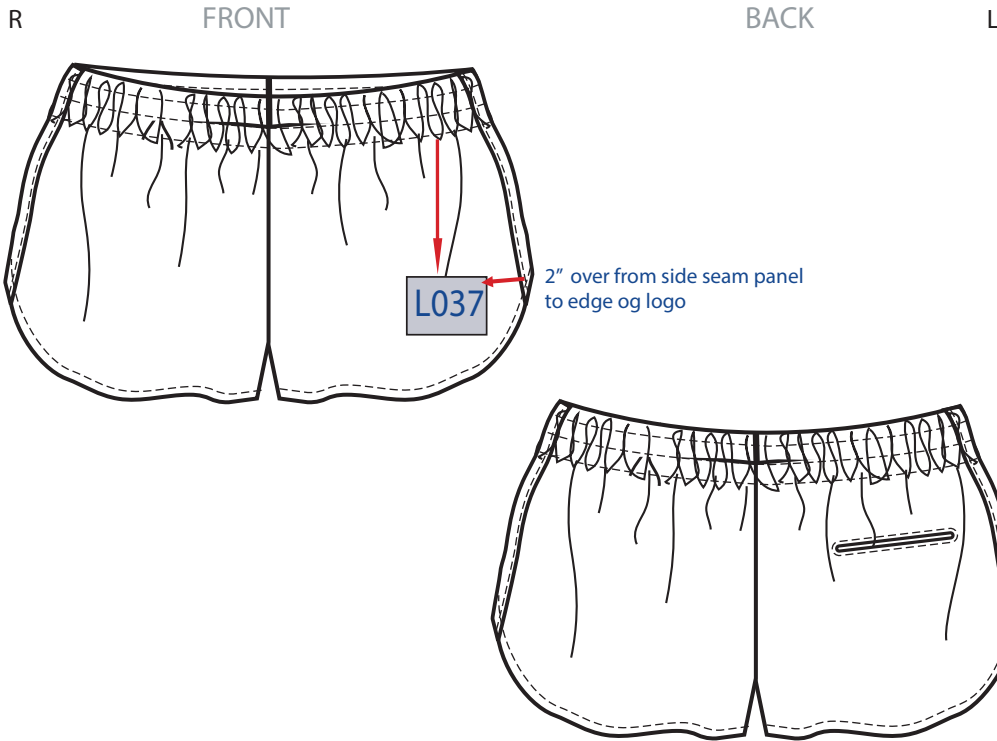

INFORMATION

- * Available in:
 - Adult XS- 2XL
 - Youth YS - YL
- * Ladies
- * 89/11 Poly/ Spandex
- * Polyester Liner
- * Hidden Key Pocket
- * Back Pocket
- * Contrast Color Stripe on Side Except for Black
- * Plush Inside Plaid Waistband

SPECIAL INSTRUCTIONS

- * Can Print on inside Waistband / White Ink Looks Best
 - * ARTIST NOTE: Art requires a GRAY and WHITE UNDERLAY.
 - * No small details or distressed art
- PRINT OPTIONS:**
ONE STROKE INK

L037 HEM

ADULT : 3 W x 3 H MAX
PLACEMENT : 5" down from bottom waistband to top of logo
 2" over from side seam panel to side of logo

YOUTH: 2 W x 2 H MAX
PLACEMENT : 3.5" down from bottom waistband to top of logo
 2" over from side seam panel to side of logo

AVAILABLE PROCESSES:



R

FRONT

L

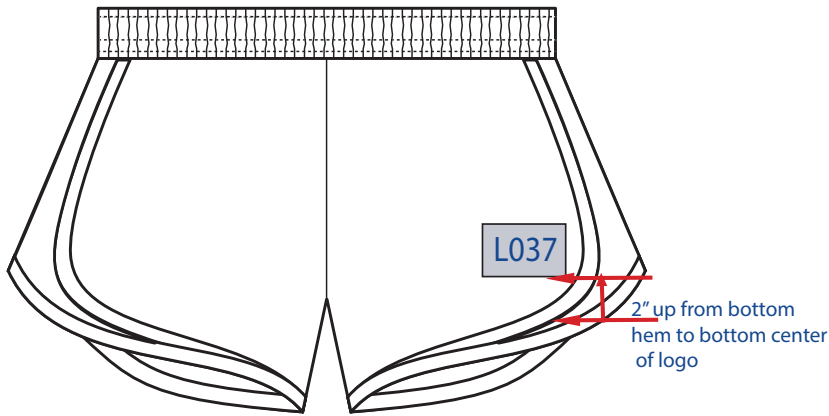

INFORMATION

- *Available in:
 - Adult XS - XL
 - Youth YS - YL
- * WOMEN'S FIT
- * 2.4 oz. 100% Polyester

SPECIAL INSTRUCTIONS

- * Side Mesh Panels Can be Solid Color or Come in Prints
- * Logos Cannot be Too Complex
- * Lettering Has to Have Proper Spacing
- * Use "ONE STROKE WHITE" Ink Print
- Screen print & embroidery
- * No small details or distressed art

L037 HEM

ADULT : 3W x 3H MAX
 PLACEMENT : 2" up from bottom hem

YOUTH: 2W x 2H MAX
 PLACEMENT : 2" up from bottom hem

AVAILABLE PROCESSES:



R FRONT BACK L

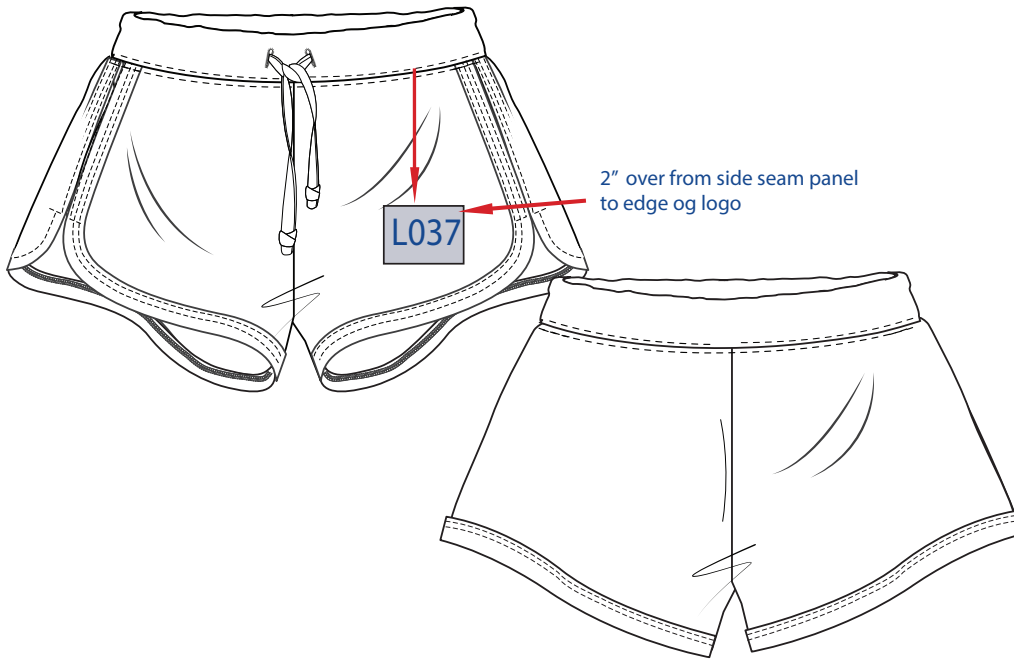

INFORMATION

- *Available in:
 Adult XS- 2X
 Youth YS - YL
- * 70/30 Cotton/Poly French Terry (exclusive of decoration)
- * Contrast jersey binding
- * Contrast twill drawcord
- * No drawcords on youth
- * 2-3/4" inseam on size small

SPECIAL INSTRUCTIONS

- * No small details or distressed art

L037 HEM

ADULT : 3 W x 3 H MAX
 PLACEMENT : 5" down from bottom waistband to top of logo
 2" over from side seam panel to side of logo

YOUTH: 2 W x 2 H MAX
 PLACEMENT : 3.5" down from bottom waistband to top of logo
 2" over from side seam panel to side of logo

AVAILABLE PROCESSES:



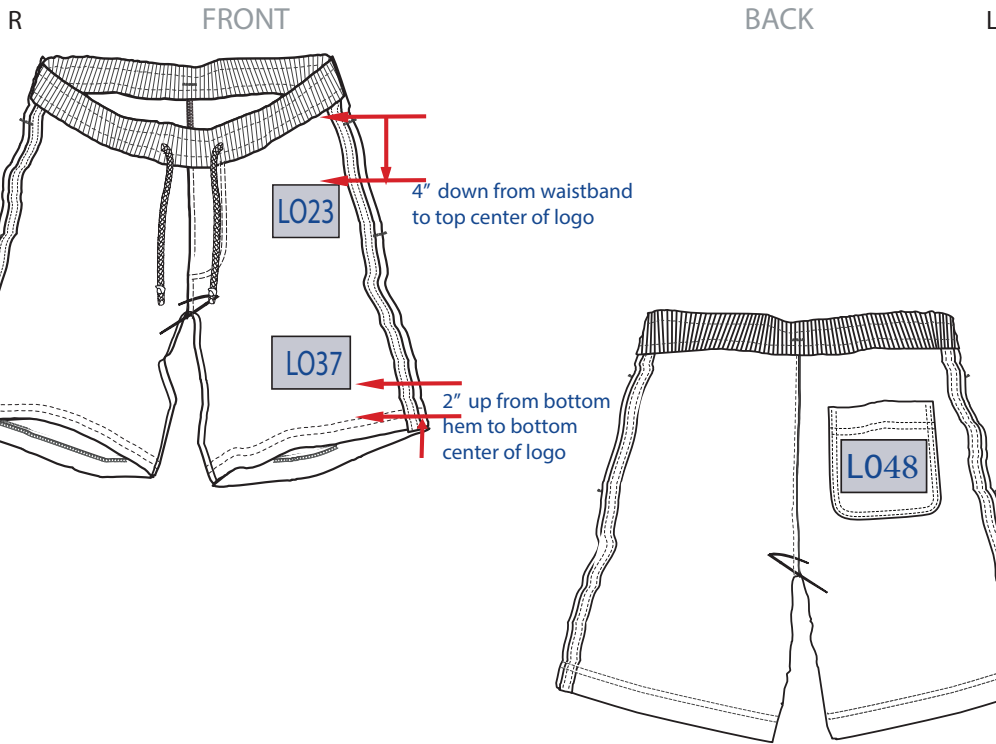

INFORMATION

- *Available in:
 Adult XS- 2X
 Youth YS- YL
- * 5.9 oz 80/17/3 Viscose/Polyester/
 Elastane Brushed Hacci Knit
 (Exclusive of decoration)
- * Folded Waistband
- * Twill Drawcord (Adult only)

SPECIAL INSTRUCTIONS

Screen print & embroidery
 *no small details or
 distressed art

L037 HEM

ADULT : 4W x 4H MAX
 PLACEMENT : 2" up from bottom of waistband

YOUTH: 3W x 3H MAX
 PLACEMENT : 2" up from bottom of waistband

L023 HIP

ADULT : 3W x 3H MAX
 PLACEMENT : 4" down from bottom of waistband

YOUTH: 2W x 2H MAX
 PLACEMENT : Centered in pocket

L048 BACK POCKET

ADULT : 3W x 3H MAX
 PLACEMENT : 4" down from bottom of waistband

YOUTH: 2W x 2H MAX
 PLACEMENT : Centered in pocket

AVAILABLE PROCESSES:



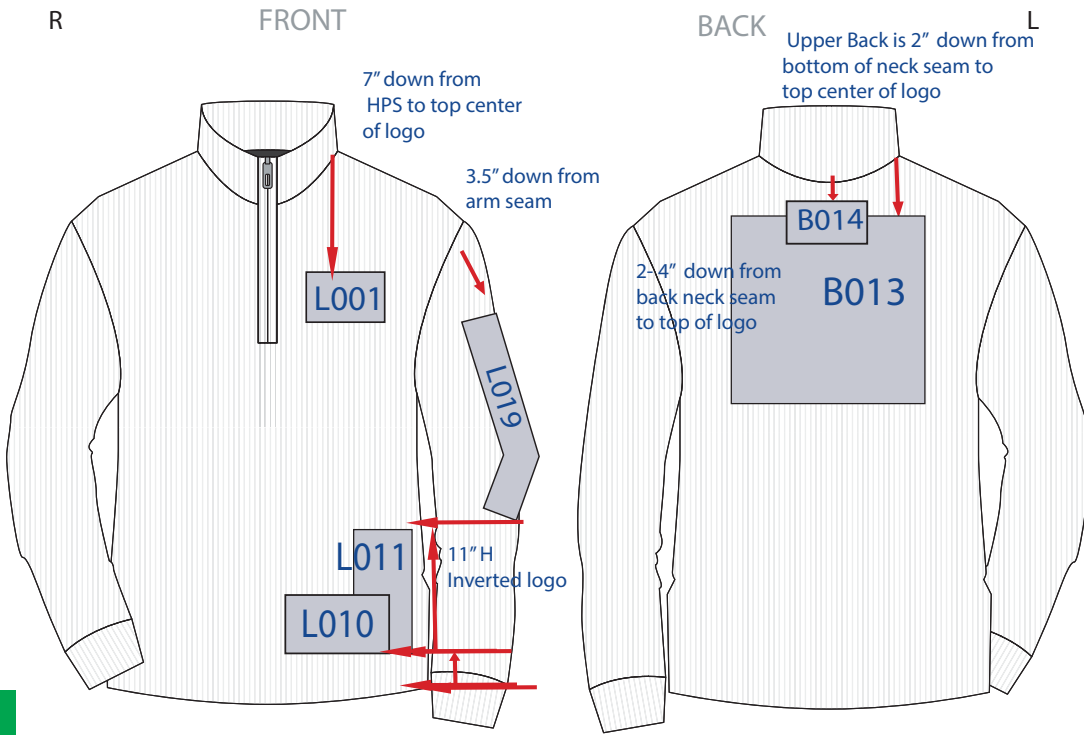

INFORMATION

- *Available in:
Adult XS - 3X
- * 8.3 oz. 60/40 Cotton/ Polyester Enzyme & Stone Washed Corduroy Knit (exclusive of decoration)
- * Collar neck w/quarter zip
- * Rib sleeve cuffs
- * Level hem
- * Side vents at side seam

SPECIAL INSTRUCTIONS

Screen print & embroidery
*NO SMALL DETAILS OR DISTRESSED ART on left chest

L001 LEFT CHEST

ADULT: 3W x 3H MAX
PLACEMENT: 7" down from High Point Shoulder point

B013 BACK CENTER

ADULT: 12W x 12H MAX
PLACEMENT: 2"-4" down from neck seam to top of logo

B014 UPPER BACK CENTER

ADULT: 3W x 3H MAX
PLACEMENT: 2"-4" down from neck seam to top of logo

L019 FULL SLEEVE

ADULT: 3W x 12H MAX
PLACEMENT: 3.5" down from arm seam

L011 INVERTED HEM

ADULT: 3W x 11H MAX
PLACEMENT: 2"-4" down from bottom hem to bottom of logo

L010 SHIRT HEM

ADULT: 4W x 4H MAX
PLACEMENT: 2" up from bottom hem to bottom of logo

AVAILABLE PROCESSES:

S E

S

S E

S

S

S

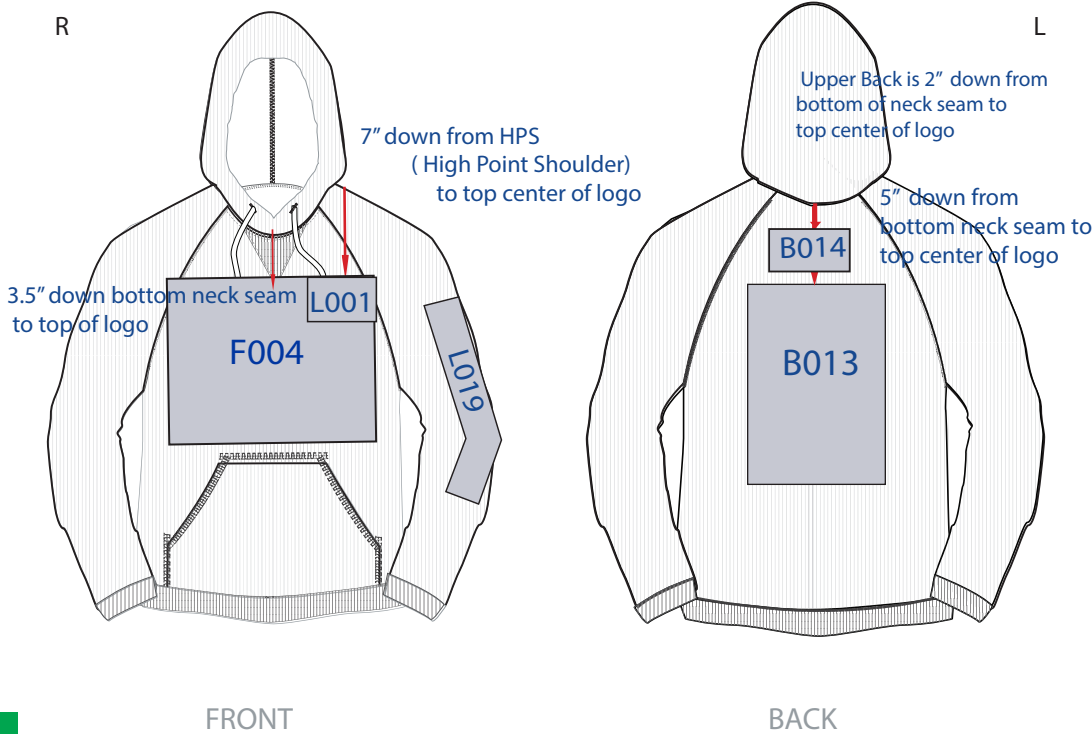

INFORMATION

- *Available in:
Adult XS- 3X
- * 8.3 oz 60/40 Cotton/Polyester Enzyme Washed Corduroy Knit (exclusive of decoration)
- * Self hood
- * Braided Cotton Drawcords
- * Rib sleeve cuffs & bottom band
- * Self Kangaroo pocket

SPECIAL INSTRUCTIONS

Screen print & embroidery
*NO SMALL DETAILS OR DISTRESSED ART on left chest

F004 FRONT CENTER

ADULT : 12W x 8H MAX
PLACEMENT : Centered 3.5" from neck seam to top of logo

L001 LEFT CHEST

ADULT : 3W x 3H MAX
PLACEMENT : 7" down from High Point Shoulder point, 2.5" over from centered

B013 BACK CENTER

ADULT : 12W x 12H MAX
PLACEMENT : 2"-4" down from neck seam to top of logo centered

B014 UPPER BACK CENTER

ADULT : 3W x 3H MAX
PLACEMENT : 2"-4" down from neck seam to top of logo centered

L019 FULL SLEEVE

ADULT : 3W x 12H MAX
PLACEMENT : 3.5" down from arm seam centered

AVAILABLE PROCESSES:



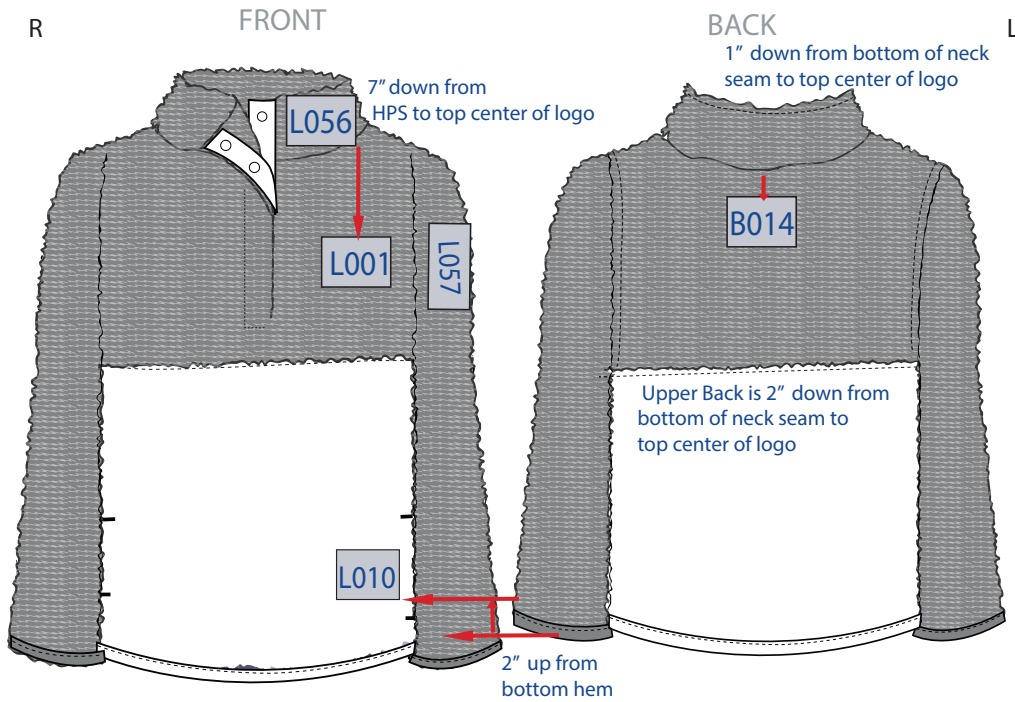

INFORMATION

- *Available in:
Adult XS - 3X
- * Top/sleeves: 6.7 oz. 100% Polyester Stipe Fuzzy Fleece (Exclusive of decoration)
- * Bottom: 8.8 oz 100% Polyester Fuzzy Fleece (Exclusive of decoration)
- * 1/4 grosgrain placket with gold snaps
- * Contrasting Collar, Upper Body, and sleeves
- * Side seam pockets
- * Sleeve and bottom opening finished w/jersey bindings

SPECIAL INSTRUCTIONS

- * Embroidery only
- * Tonal backing used

L001 LEFT CHEST

ADULT: 2.7W x 2.7H MAX
 PLACEMENT: 7" down from high point shoulder to top of logo
 YOUTH: 2.5W x 2.5H MAX
 PLACEMENT: 7" down from high point shoulder to top of logo

L010 SHIRT HEM

ADULT: 2.7W x 2.7H MAX
 PLACEMENT: 2" up from bottom hem to bottom of logo
 YOUTH: 2.5W x 2.5H MAX
 PLACEMENT: 2" up from bottom hem to bottom of logo

B014 UPPER BACK CENTER

ADULT: 2.7W x 2.7H MAX
 PLACEMENT: 2"-4" down from neck seam to top of logo
 YOUTH: 2.5W x 2.5H MAX
 PLACEMENT: 2" down from bottom center neck seam centered on back neck

L057 SHOULDER SLEEVE

ADULT: 2.7W x 2.7H MAX
 PLACEMENT: 2"-4" down from neck seam to top of logo
 YOUTH: 2.5W x 2.5H MAX
 PLACEMENT: 2" down from bottom arm hole seam centered on sleeve

L056 COLLAR

ADULT: 2.7W x 2.7H MAX
 PLACEMENT: Centered on collar
 YOUTH: 2.5W x 2.5H MAX
 PLACEMENT: Centered on collar

AVAILABLE PROCESSES:

E

E

E

E

E

R

FRONT

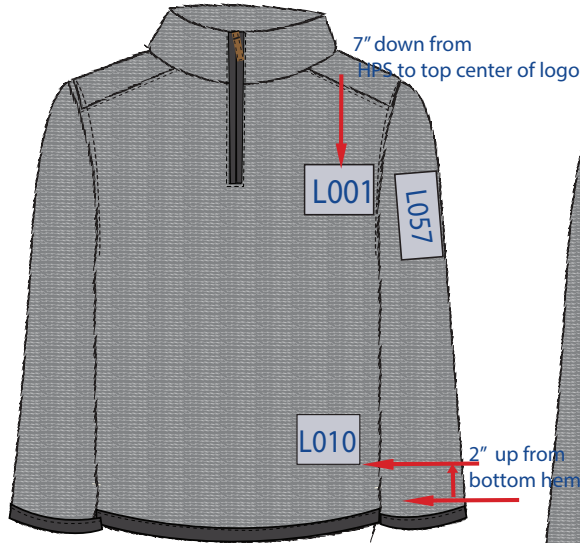

BACK

L

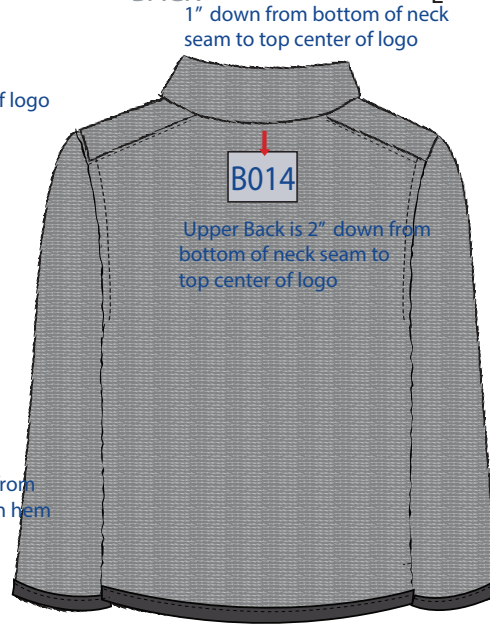

INFORMATION

- *Available in:
Adult S - 3X
- * 6.7 oz. 100% Polyester Stipe Fuzzy Fleece (Exclusive of decoration)
- * Faux Leather Zipper Pull
- * Tonal jersey bindings at center front zipper
- * Sleeve and Bottom opening finished w/ jersey bindings

SPECIAL INSTRUCTIONS

- * Embroidery only

L001 LEFT CHEST

ADULT: 2.7W x 2.7H MAX
 PLACEMENT: 7" down from high point shoulder to top of logo
 YOUTH: 2.5W x 2.5H MAX
 PLACEMENT: 7" down from high point shoulder to top of logo

L010 SHIRT HEM

ADULT: 2.7W x 2.7H MAX
 PLACEMENT: 2" up from bottom hem to bottom of logo
 YOUTH: 2.5W x 2.5H MAX
 PLACEMENT: 2" up from bottom hem to bottom of logo

B014 UPPER BACK CENTER

ADULT: 2.7W x 2.7H MAX
 PLACEMENT: 2"-4" down from neck seam to top of logo
 YOUTH: 2.5W x 2.5H MAX
 PLACEMENT: 2" down from bottom center neck seam centered on back neck

L057 SHOULDER SLEEVE

ADULT: 2.7W x 2.7H MAX
 PLACEMENT: 2"-4" down from neck seam to top of logo
 YOUTH: 2.5W x 2.5H MAX
 PLACEMENT: 2" down from bottom arm hole seam centered on sleeve

AVAILABLE PROCESSES:

E

E

E

E

R

FRONT

6.5" down from HPS
to center top of logo



BACK

2" down from bottom Mid back
seam to center top of logo

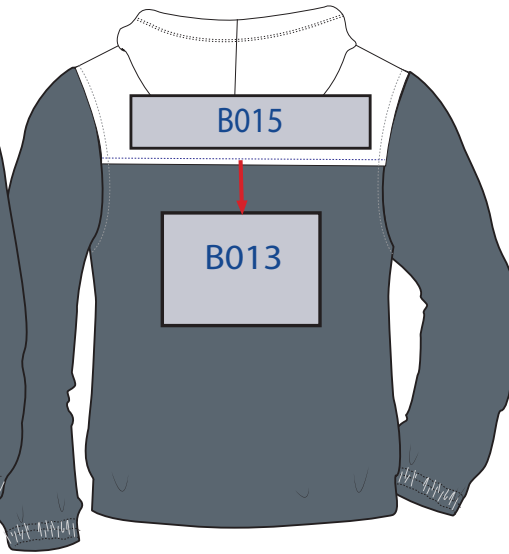

L

INFORMATION

- *Available in:
 - Adult XS - 3X
- * 2.1 oz. 100% Polyester (Exclusive of decoration)
- * Quarter zip detail
- * Gold accents: zipper, grommets, aglets, and bungee stopper
- * Entire body is lined with mesh
- * Front pockets
- * Shirred sleeve cuff
- * Cinched bottom opening with bungee

SPECIAL INSTRUCTIONS

- *Screen print & Embroidery
- *2 INK COLOR maximum per graphic
- *Barrier Base & Poly Base required double passes w/flash between

L001 LEFT CHEST

ADULT : 3W x3H MAX
PLACEMENT : 6.5" down from HPS to top of logo

B013 BACK CENTER

ADULT : 12W x 12H MAX
PLACEMENT: 2" down from mid back seam to top center of logo

B015 UPPER BACK

ADULT : 10W x 2 H MAX
PLACEMENT: 1" up from mid back seam to bottom of center of logo

AVAILABLE PROCESSES:



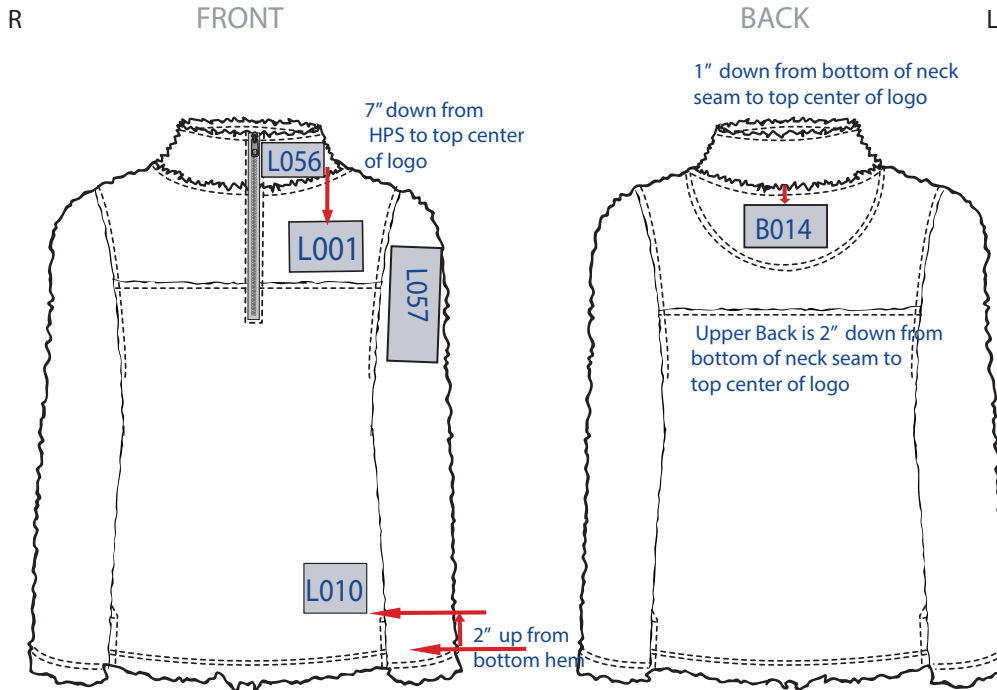

INFORMATION

- * Available in:
 - Adult XS - 2X
 - Youth YS - YL
- * 9.7oz., 100% polyester two-toned Sherpa
- * Self-fabric collar dyed to match stitching
- * Half moon back yoke
- * Twill tape inside neck trim
- * Ladies fit quarter zip

SPECIAL INSTRUCTIONS

- * Embroidery Only
- * Tonal backing used

L001 LEFT CHEST

ADULT: 2.7W x 2.7H MAX
 PLACEMENT: 1/2" up from center chest seam
 YOUTH: 2.5W x 2.5H MAX
 PLACEMENT: 1/2" up from center chest seam

L010 SHIRT HEM

ADULT: 2.7W x 2.7H MAX
 PLACEMENT: 2" up from bottom hem to bottom of logo
 YOUTH: 2.5W x 2.5H MAX
 PLACEMENT: 2" up from bottom hem to bottom of logo

B014 UPPER BACK CENTER

ADULT: 2.7W x 2.7H MAX
 PLACEMENT: 2"-4" down from neck seam to top of logo
 YOUTH: 2.5W x 2.5H MAX
 PLACEMENT: 2" down from bottom center neck seam centered on back neck

L057 SHOULDER SLEEVE

ADULT: 2.7W x 2.7H MAX
 PLACEMENT: 2"-4" down from neck seam to top of logo
 YOUTH: 2.5W x 2.5H MAX
 PLACEMENT: 2" down from bottom arm hole seam centered on sleeve

L056 COLLAR

ADULT: 2.7W x 2.7H MAX
 PLACEMENT: 1" down from neck seam centered to top of logo
 YOUTH: 2.5W x 2.5H MAX
 PLACEMENT: .75" down from neck seam centered to top of logo

AVAILABLE PROCESSES:

E

E

E

E

E

R

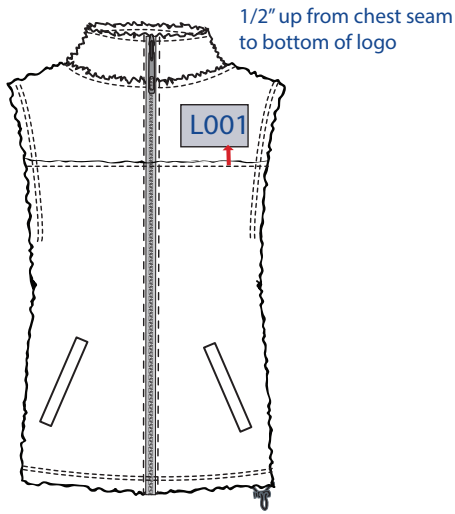

FRONT

L

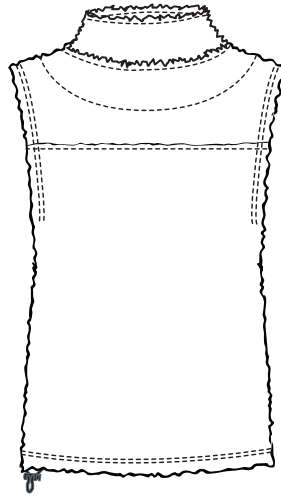

BACK

INFORMATION

- * Available in:
 - Adult XS - 2X
 - Youth YS - YL
- * 8.9 oz. 100% Polyester 2 toned Sherpa (Exclusive of decoration)
- * Self-fabric collar dyed to match stitching
- * Half moon back yoke
- * Twill tape inside neck trim
- * No toggle on girls
- (The dye process used to produce this garment infuses each with unique character. Please allow for color variations in production)

SPECIAL INSTRUCTIONS

- * Embroidery only
- * Tonal backing used

L001 LEFT CHEST

ADULT : 2.7W x 2.7H MAX
 PLACEMENT : 1/2" up from chest seam to bottom of logo
 2.5" over from center

YOUTH : 2.5W x 2.5H MAX
 PLACEMENT : 1/2" up from chest seam to bottom of logo
 2.5" over from center

AVAILABLE PROCESSES:

E

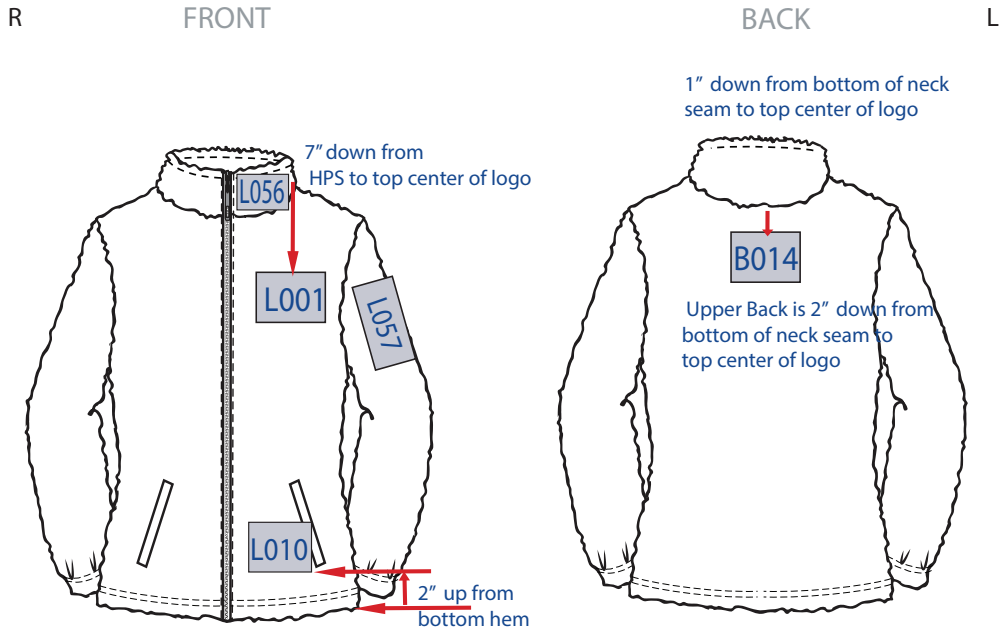

INFORMATION

- *Available in:
 - Adult XS - 3X
 - Youth YS - YL
- * 8.9 oz. 100% Polyester Sherpa (Exclusive of decoration)
- * Collar and half moon facing at back neck
- * Zipper at front opening
- * Welt pockets on front body
- * Gathered sleeve opening with elastic cuff
- * No toggle on girls
- (The dye process used to produce this garment infuses each with unique character. Please allow for color variations in production)

SPECIAL INSTRUCTIONS

- * Embroidery only
- * Tonal backing used

L001 LEFT CHEST

ADULT: 2.7W x 2.7H MAX
 PLACEMENT: 7" down from high point shoulder to top of logo
 YOUTH: 2.5W x 2.5H MAX
 PLACEMENT: 7" down from high point shoulder to top of logo

L010 SHIRT HEM

ADULT: 2.7W x 2.7H MAX
 PLACEMENT: 2" up from bottom hem to bottom of logo
 YOUTH: 2.5W x 2.5H MAX
 PLACEMENT: 2" up from bottom hem to bottom of logo

B014 UPPER BACK CENTER

ADULT: 2.7W x 2.7H MAX
 PLACEMENT: 2"-4" down from neck seam to top of logo
 YOUTH: 2.5W x 2.5H MAX
 PLACEMENT: 2" down from bottom center neck seam centered on back neck

L057 SHOULDER SLEEVE

ADULT: 2.7W x 2.7H MAX
 PLACEMENT: 2"-4" down from neck seam to top of logo
 YOUTH: 2.5W x 2.5H MAX
 PLACEMENT: 2" down from bottom arm hole seam centered on sleeve

L056 COLLAR

ADULT: 2.7W x 2.7H MAX
 PLACEMENT: Centered on collar
 YOUTH: 2.5W x 2.5H MAX
 PLACEMENT: Centered on collar

AVAILABLE PROCESSES:

E

E

E

E

E

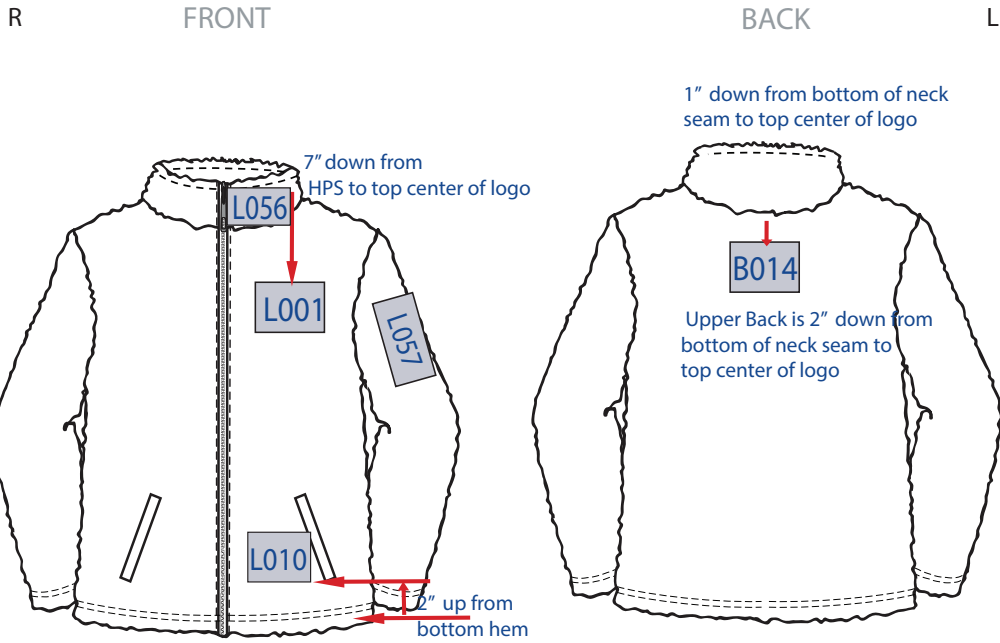

INFORMATION

- *Available in:
 - Adult XS - 3X
 - Youth YS - YL
- * 8.9 oz. 100% Polyester Sherpa (Exclusive of decoration)
- * Collar and half moon facing at back neck
- * Zipper at front opening
- * Welt pockets on front body
- * Gathered sleeve opening with elastic cuff
- (The dye process used to produce this garment infuses each with unique character. Please allow for color variations in production)

SPECIAL INSTRUCTIONS

- * Embroidery only
- * Tonal backing used

L001 LEFT CHEST

ADULT: 2.7W x 2.7H MAX
 PLACEMENT: 7" down from high point shoulder to top of logo
 YOUTH: 2.5W x 2.5H MAX
 PLACEMENT: 7" down from high point shoulder to top of logo

L010 SHIRT HEM

ADULT: 2.7W x 2.7H MAX
 PLACEMENT: 2" up from bottom hem to bottom of logo
 YOUTH: 2.5W x 2.5H MAX
 PLACEMENT: 2" up from bottom hem to bottom of logo

B014 UPPER BACK CENTER

ADULT: 2.7W x 2.7H MAX
 PLACEMENT: 2"-4" down from neck seam to top of logo
 YOUTH: 2.5W x 2.5H MAX
 PLACEMENT: 2" down from bottom center neck seam centered on back neck

L057 SHOULDER SLEEVE

ADULT: 2.7W x 2.7H MAX
 PLACEMENT: 2"-4" down from neck seam to top of logo
 YOUTH: 2.5W x 2.5H MAX
 PLACEMENT: 2" down from bottom arm hole seam centered on sleeve

L056 COLLAR

ADULT: 2.7W x 2.7H MAX
 PLACEMENT: Centered on collar
 YOUTH: 2.5W x 2.5H MAX
 PLACEMENT: Centered on collar

AVAILABLE PROCESSES:

E

E

E

E

E

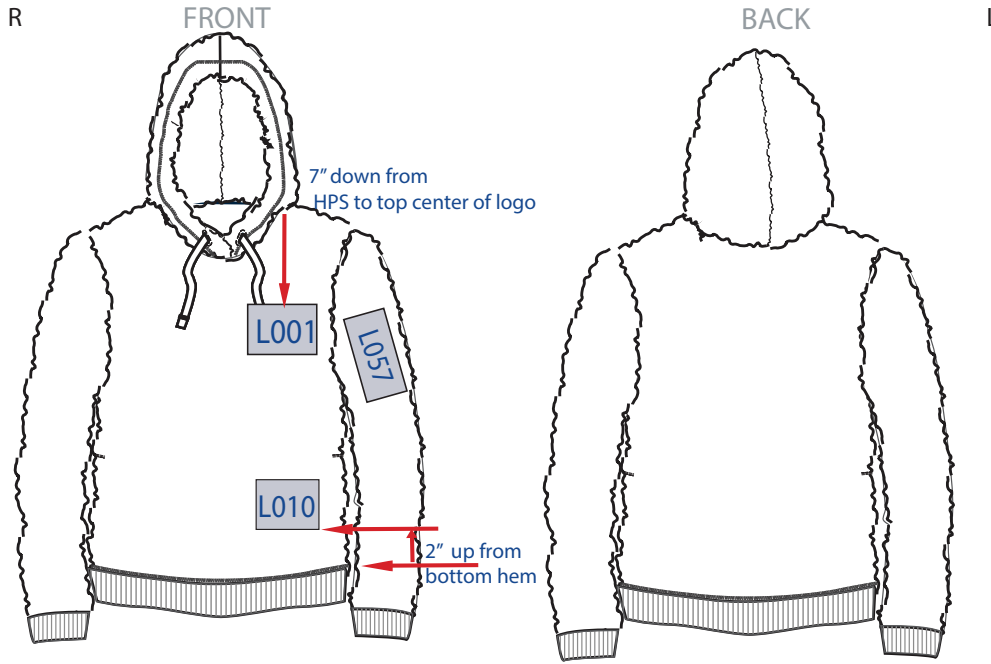

INFORMATION

- *Available in:
 - Adult XS - 3X
 - Youth YS - YL
- * 7.4 oz. 100% Polyester Double faced Sherpa (Exclusive of decoration)
- * Twill drawcords (No drawcords on youth)
- * Rib sleeve cuffs and bottom band
- * Side seam pockets (The dye process used to produce this garment infuses each with unique character. Please allow for color variations in production)

SPECIAL INSTRUCTIONS

- * Embroidery only
- * Tonal backing used

L001 LEFT CHEST

ADULT: 2.7W x 2.7H MAX
 PLACEMENT: 7" down from high point shoulder to top of logo
 YOUTH: 2.5W x 2.5H MAX
 PLACEMENT: 7" down from high point shoulder to top of logo

L010 SHIRT HEM

ADULT: 2.7W x 2.7H MAX
 PLACEMENT: 2" up from bottom hem to bottom of logo
 YOUTH: 2.5W x 2.5H MAX
 PLACEMENT: 2" up from bottom hem to bottom of logo

L057 SHOULDER SLEEVE

ADULT: 2.7W x 2.7H MAX
 PLACEMENT: 2"-4" down from neck seam to top of logo
 YOUTH: 2.5W x 2.5H MAX
 PLACEMENT: 2" down from bottom arm hole seam centered on sleeve

AVAILABLE PROCESSES:

E

E

E

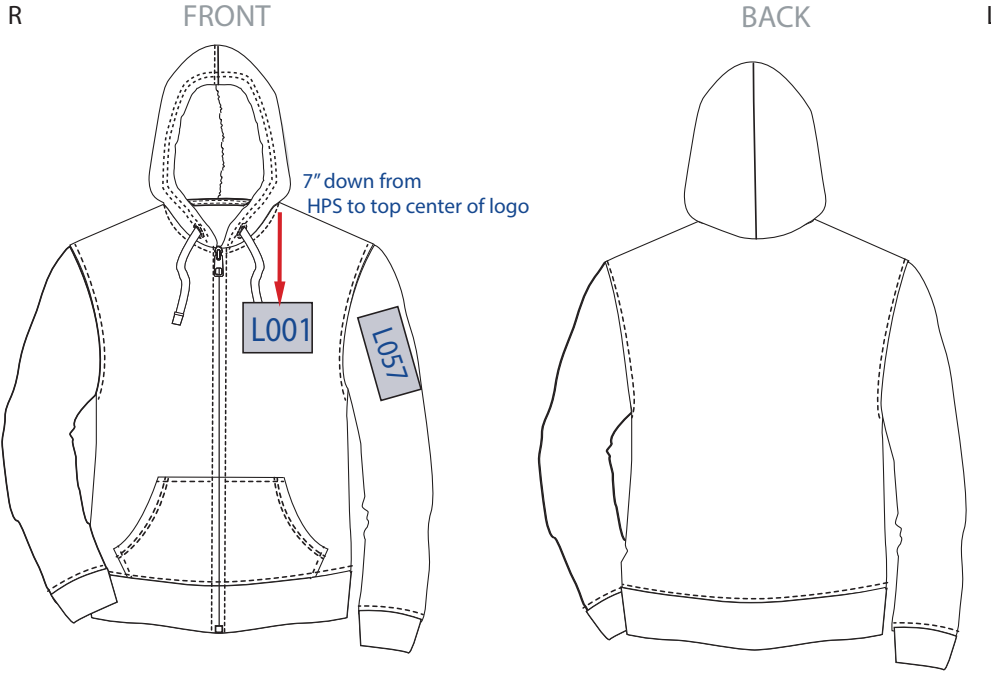

INFORMATION

- *Available in:
 - Adult XS - 3X
 - Youth YS - YL
- * 6.5 oz. 60/40 Cotton/ Polyester fleece (body)
- 8.9 oz, 100% Polyetser Sherpa (Exclusive of decoration)
- * Sherpa lining in hood and body
- *Twill drawcords at bottom of hood opening (No drawcords on youth)
- * Rib sleeve cuffs and bottom band
- * Self kangaroo pocket

SPECIAL INSTRUCTIONS

Embroidery only

L001 LEFT CHEST

ADULT: 2.7W x 2.7H MAX
 PLACEMENT : 7" down from high point shoulder to top of logo
 YOUTH: 2.5W x 2.5H MAX
 PLACEMENT : 7" down from high point shoulder to top of logo

L057 SHOULDER SLEEVE

ADULT : 2.7W x 2.7H MAX
 PLACEMENT : 2"-4" down from neck seam to top of logo
 YOUTH: 2.5W x 2.5H MAX
 PLACEMENT : 2" down from bottom arm hole seam centered on sleeve

AVAILABLE PROCESSES:

E

E

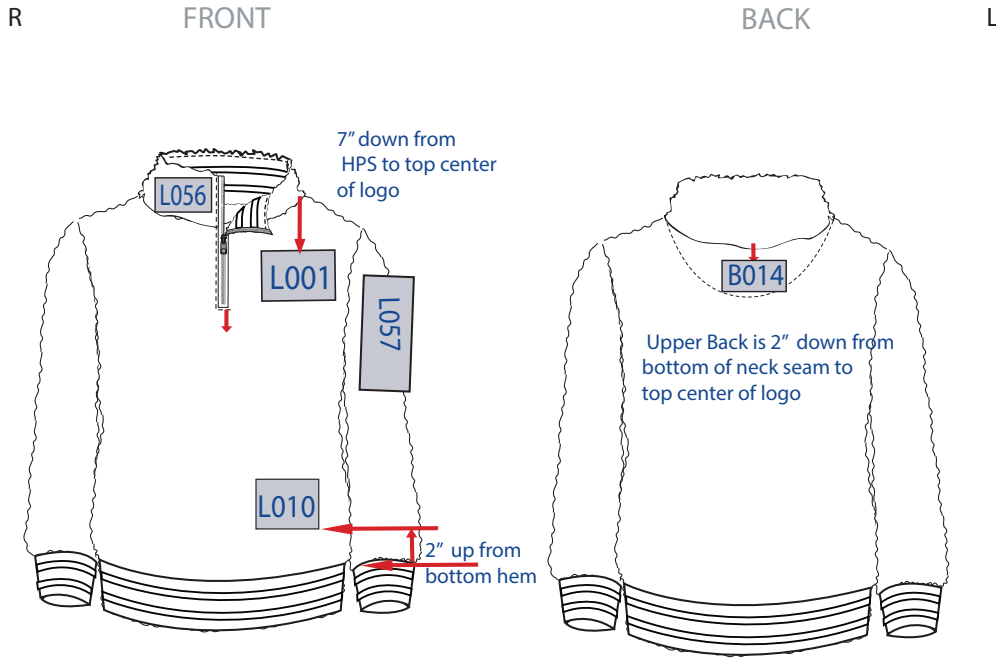

INFORMATION

*Available in:
Adult XS - 3X

- * 7.4 oz. 100% Polyester Double faced Sherpa (Exclusive of decoration)
 - * Collar w/striped rib interior
 - * Quarter zipper
 - * Striped sleeve cuffs and bottom band
- (The dye process used to produce this garment infuses each with unique character. Please allow for color variations in production)

SPECIAL INSTRUCTIONS

- * Embroidery Only
- * Tonal Backing Used

L001 LEFT CHEST

ADULT: 2.7W x 2.7H MAX
 PLACEMENT: 6" down from HPS to top of centered logo
 YOUTH: 2.5W x 2.5H MAX
 PLACEMENT: 6" down from HPS to top of centered logo

L010 SHIRT HEM

ADULT: 2.7W x 2.7H MAX
 PLACEMENT: 2" up from bottom hem to bottom of logo
 YOUTH: 2.5W x 2.5H MAX
 PLACEMENT: 2" up from bottom hem to bottom of logo

B014 UPPER BACK CENTER

ADULT: 2.7W x 2.7H MAX
 PLACEMENT: 2"-4" down from neck seam to top of logo
 YOUTH: 2.5W x 2.5H MAX
 PLACEMENT: 2" down from bottom center neck seam centered on back neck

L057 SHOULDER SLEEVE

ADULT: 2.7W x 2.7H MAX
 PLACEMENT: 2"-4" down from neck seam to top of logo
 YOUTH: 2.5W x 2.5H MAX
 PLACEMENT: 2" down from bottom arm hole seam centered on sleeve

L056 COLLAR

ADULT: 2.7W x 2.7H MAX
 PLACEMENT: Centered on collar
 YOUTH: 2.5W x 2.5H MAX

AVAILABLE PROCESSES:

E

E

E

E

E

R

FRONT

BACK

L

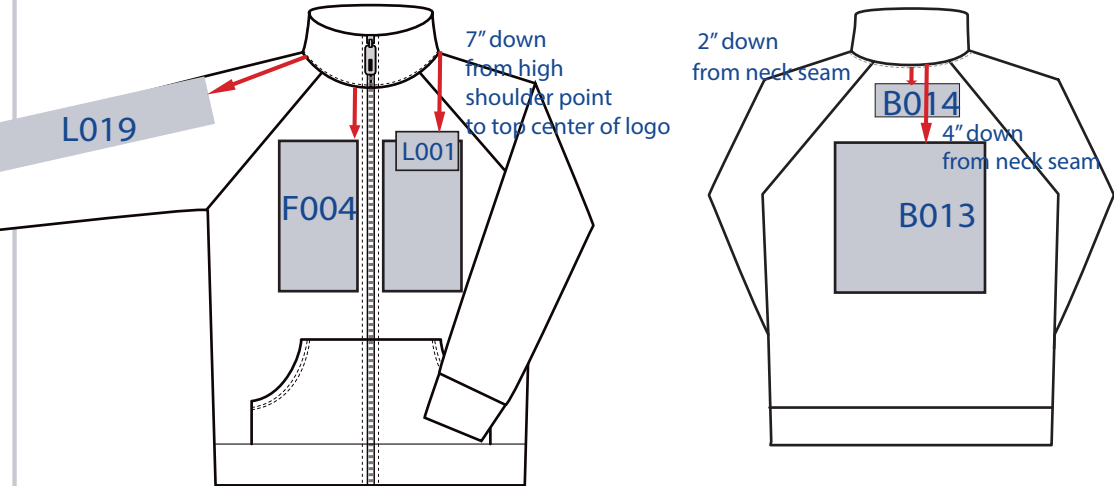

INFORMATION

*Available in:
 Adult XS - XL
 Youth YS - YL
 * 6.5 oz 90 / 10 Cotton Spandex

SPECIAL INSTRUCTIONS

* Screen print only
 * No small detail or distressed art on left chest

L001 LEFT CHEST

ADULT : 3W x 3H MAX
 PLACEMENT : 7" down from High Shoulder point
 YOUTH: 2W x 2H MAX
 PLACEMENT : 7" down from High Shoulder point

L019 FULL SLEEVE

ADULT : 3W x 12 H MAX
 PLACEMENT : Centered on sleeve 3" down from armhole seam
 YOUTH: 2W x 10H MAX
 PLACEMENT : Centered on sleeve 2" down from armhole seam

B014 UPPER BACK CENTER

ADULT : 3W x 3H MAX
 PLACEMENT : 2" down from neck seam
 YOUTH: 2W x 2H MAX
 PLACEMENT : 2" down from neck seam

B013 BACK CENTER

ADULT : 12W x 12H MAX
 PLACEMENT : 4" down from bottom of neck seam centered on back
 YOUTH: 10W x 10H MAX
 PLACEMENT : 4" down from bottom of neck seam centered on back

F004 FRONT CENTER

ADULT : 12W x 10H MAX
 PLACEMENT : 2.5"-3.5" down from bottom of neck seam centered on back; 2" gap for zipper
 YOUTH: 10W x 7H MAX
 PLACEMENT : 2.5"-3.5" down from bottom of neck seam centered on back; 2" gap for zipper

AVAILABLE PROCESSES:

S E

S

S E

S

S

R

FRONT

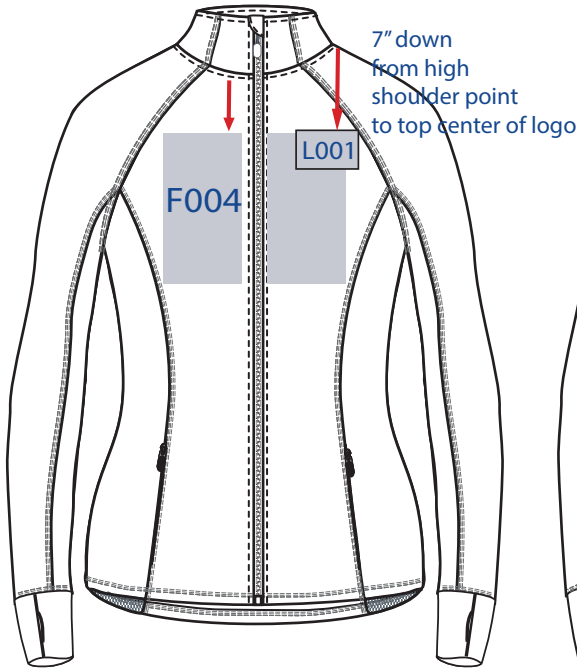

BACK

L

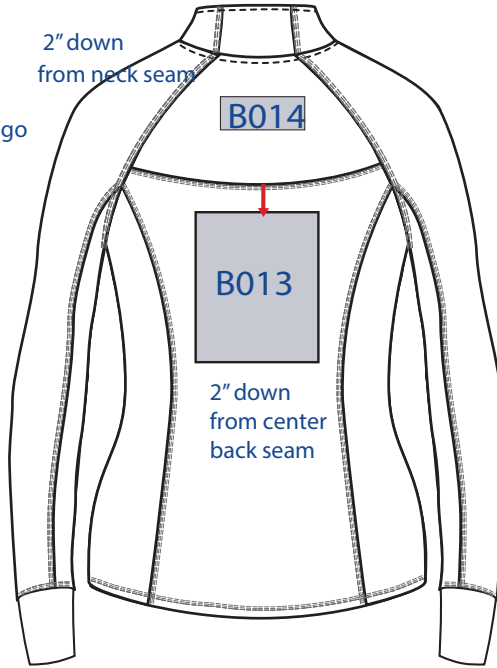

INFORMATION

- *Available in:
 - Adult XS- 2XL
 - Youth YS - YL
 - Plus 1XP-4XP
- * Ladies
- * 88 /12 Poly/ Spandex
- * Full Zip
- * Zipper Pockets
- * Color Blocking
- * Thumb Hole on Sleeve
- * Back Drops

SPECIAL INSTRUCTIONS

- * Screen print & Embroidery
- * No small detail or distressed art on left chest
- * SILICONE INK ONLY

L001 LEFT CHEST

ADULT : 3W x 3H MAX
 PLACEMENT : 7" down from High Shoulder point

YOUTH: 2W x 2H MAX
 PLACEMENT : 7" down from High Shoulder point

B014 UPPER BACK CENTER

ADULT : 4W x 2H MAX
 PLACEMENT : 2" down from neck seam

YOUTH: 3W x 1.5H MAX
 PLACEMENT : 2" down from neck seam

B013 BACK CENTER

ADULT : 8W x 7H MAX
 PLACEMENT : 2" down from center back seam centered on back

YOUTH: 7W x 6H MAX
 PLACEMENT : 2" down from center back seam centered on back

F004 FRONT CENTER

ADULT : 12W x 10H MAX
 PLACEMENT : 2.5"-3.5" down from bottom of neck seam centered on back; 2" gap for zipper

YOUTH: 10W x 7H MAX
 PLACEMENT : 2.5"-3.5" down from bottom of neck seam centered on back; 2" gap for zipper

AVAILABLE PROCESSES:

S E

S E

S

S

R

FRONT

BACK

L

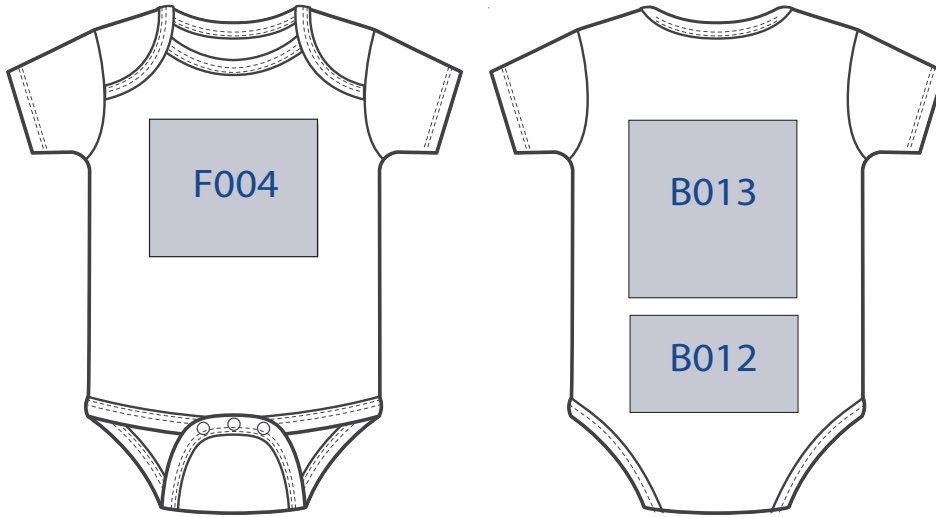

INFORMATION

- *Available in:
0-24 Months
- * 100% Cotton

SPECIAL INSTRUCTIONS

- *Screen print only
- *No small detail or distressed art

F004 FRONT CENTER

YOUTH : 3.5W x 6 H
 PLACEMENT : 2.25" down centered from neck seam to top of logo

B013 BACK CENTER

YOUTH : 3.5W x 6H
 PLACEMENT : 2.25" down centered from neck seam to top of logo

B012 BUTT

YOUTH : 3.5W x 3H
 PLACEMENT : Bottom of logo even to top of leg opening trim-centered logo

AVAILABLE PROCESSES:



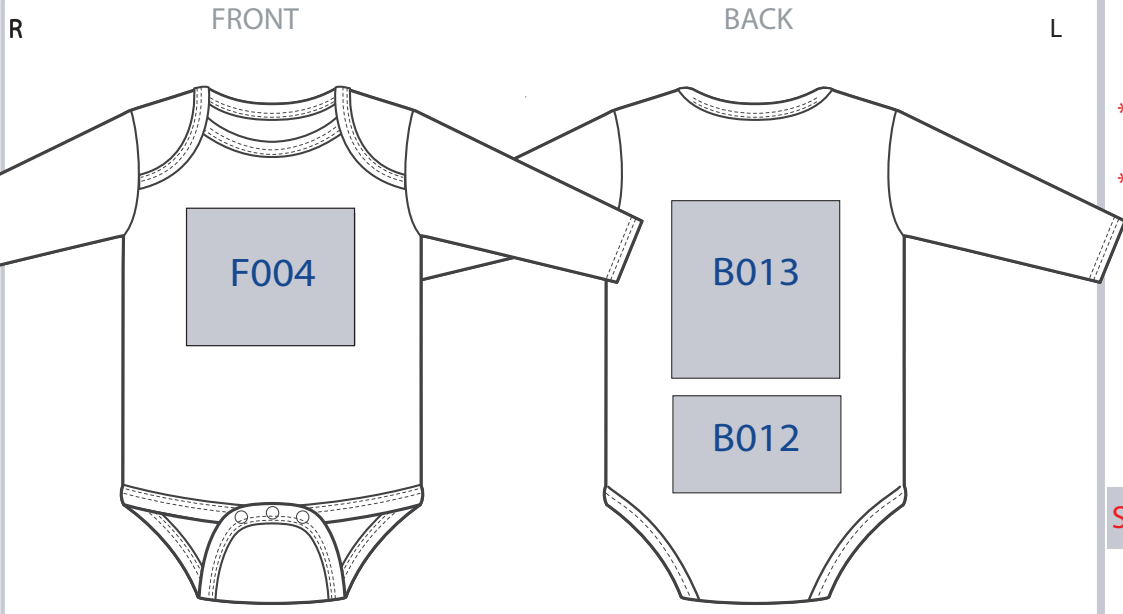

INFORMATION

- *Available in:
0-24 Months
- * 100% Cotton

SPECIAL INSTRUCTIONS

- *Screen print only
- *No small detail or distressed art

F004 FRONT CENTER

YOUTH : 3.5W x 6 H
 PLACEMENT : 2.25" down centered from neck seam to top of logo

B013 BACK CENTER

YOUTH : 3.5W x 6H
 PLACEMENT : 2.25" down centered from neck seam to top of logo

B012 BUTT

YOUTH : 3.5W x 3H
 PLACEMENT : Bottom of logo even to top of leg opening trim-centered logo

AVAILABLE PROCESSES:

- S
- S
- S

R

FRONT

L

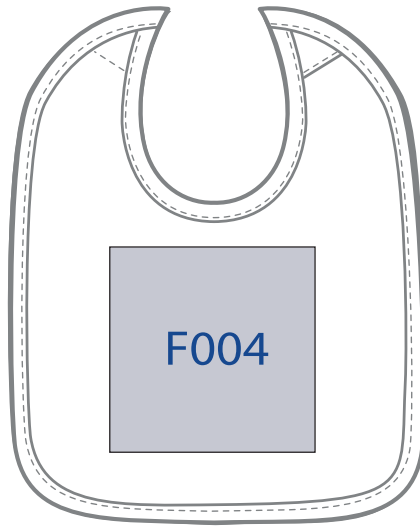

INFORMATION

*Available in:
ONE SIZE

SPECIAL INSTRUCTIONS

*Screen print only

F004 FRONT CENTER

YOUTH : 4W x4H
PLACEMENT : Centered on bib.

AVAILABLE PROCESSES:



R
Print available in any corner.
Size upon request.

FRONT
50"

L

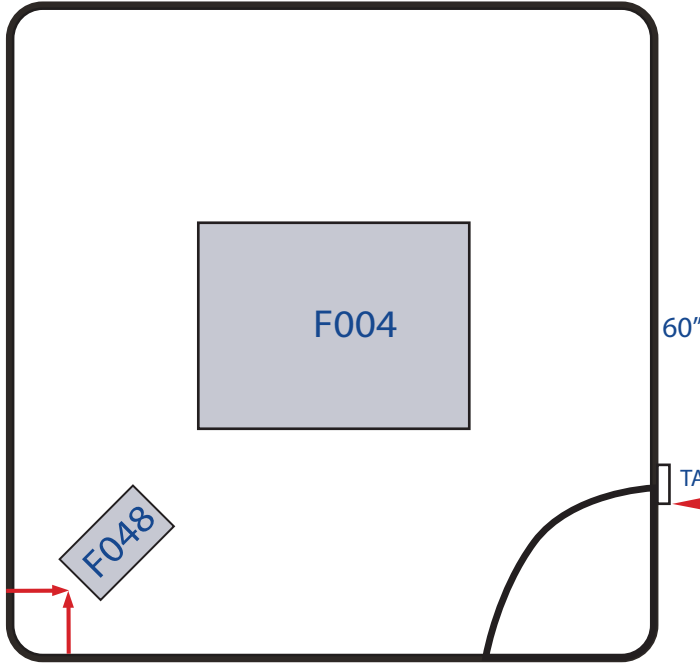

4" from side edge of blanket to edge of logo
4" from bottom edge of blanket to edge of logo

INFORMATION

- * Size 50" x 60"
- * 4.5 oz. 100% Double- Brushed Cotton Flannel
- * 60/40 Cotton Poly Fleece Backing
- * Bound and Finished Edges
- * Rectangle

SPECIAL INSTRUCTIONS

- * No more than 3 color ink can be printed
- * PRINT OPTION: MANUAL PRESS ONLY

F004 CENTER PRINT

SIZE: 12W x 12H MAX
PLACEMENT: 30" to center from long side
25" from short side to center of logo
(logo shapes will vary)
Logo centered on middle of blanket

F048 CORNER POCKET

SIZE: 5W x 5H OR UPON REQUEST
PLACEMENT: 4" up from hem 4" over from side

AVAILABLE PROCESSES:



****PRINTER NOTE:**
In the case that there is a CUSTOM fabric blanket, ignore using the tag as a reference as to which direction to print the logo. Print logo relative to where the art is facing the proper direction of the custom fabric art/pattern.

R FRONT BACK L

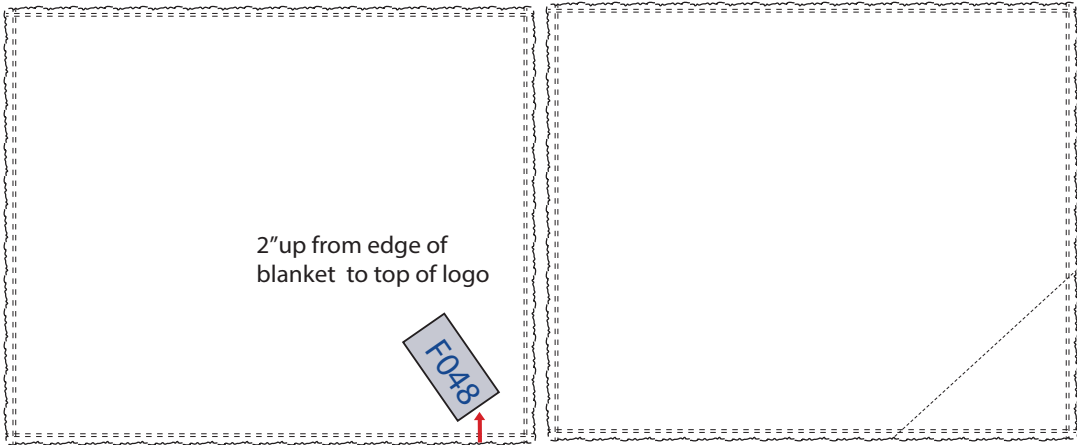

INFORMATION

- *Available in:
- * 7.4 oz. 100% Polyester Double-Faced Sherpa (Exclusive of decoration)
- * Finished edges
- * Zipper pocket to conceal embroidery backing (5.9 oz., 100% Polyester/Microfleece)

Size: 50 inches x 60 inches

SPECIAL INSTRUCTIONS

Embroidery only

F048 CORNER POCKET

SIZE : 3.5W x 3.5H MAX
 PLACEMENT : 2" up from edge of blanket to top of logo

AVAILABLE PROCESSES:



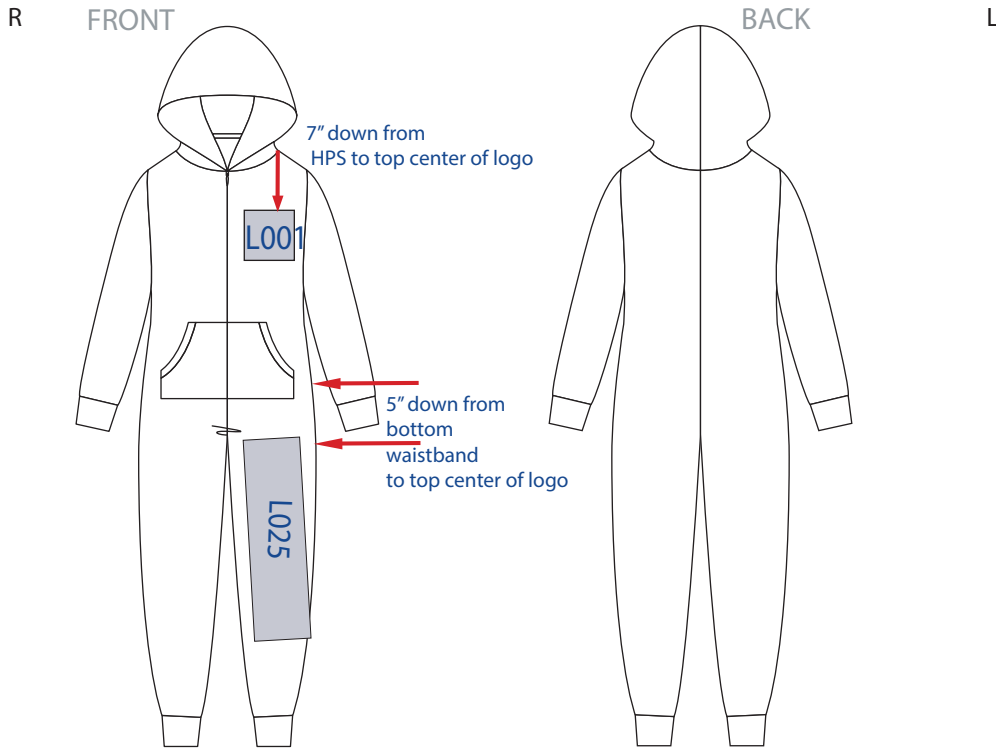

INFORMATION

- *Available in:
Adult S - 2X
- * 4.4 oz. 100% Polyester microfleece (Exclusive of decoration)
- * Hood
- * Full front zip
- * Front pouch pockets
- * Rib cuffs on legs and arms

SPECIAL INSTRUCTIONS

Screen print & Embroidery

L001 LEFT CHEST

ADULT : 3W x 3H MAX
 PLACEMENT : 7" down from High Point Shoulder to top of logo

L025 FRONT LEG CENTER

ADULT : 4W x 18H MAX
 PLACEMENT : 5" down from bottom pocket to top of logo and centered on leg

AVAILABLE PROCESSES:

